

REV	ECN NO	OR DESCRIPTION	REVISED	DATE
B	ECN NO: 7070078		EVEN	2007.3.9

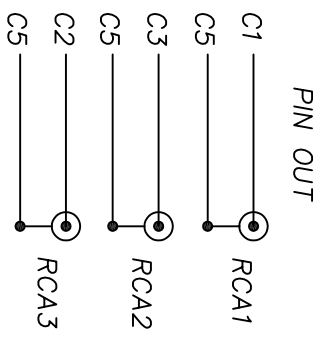
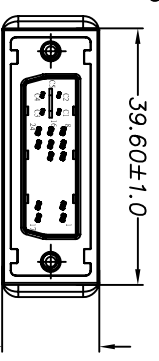
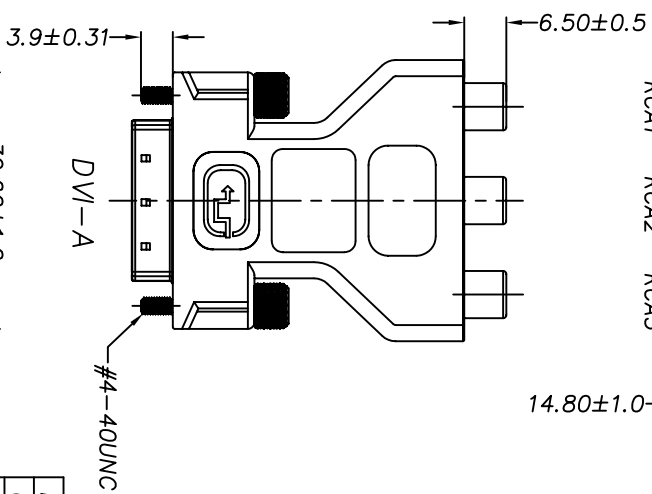
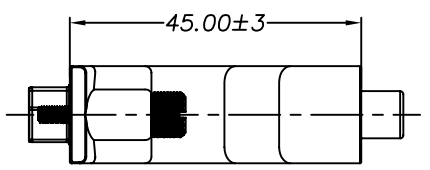
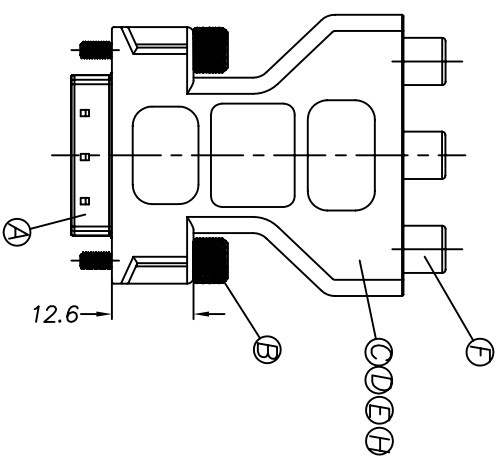
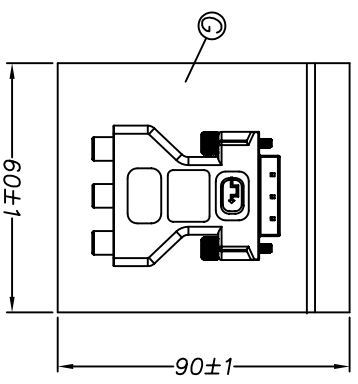
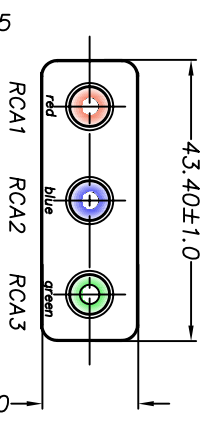

PART NO.
2DS1501-000111

- INSULATOR COLOR 1: BLACK COLOR
- CONTACT PLATING 1: GOLD FLASH
- PACKING 1: TRAY

- SPECIFICATION:
1. open/short/intermittent: 100% Testing line-process.
 2. Insulation resistance: 10M ohm(MIN) /250V DC.
 3. Contact resistance: 5 ohm(MAX).
 4. Solder heat resistance : wave soldering 260°C 10 secs
 5. To conform to the "SE-01-001"& "ROHS directive".
 6. Green product identification label in packing: **G.P. PASS**
 7. For wave soldering lead-free process.

H	H.S TUBE:Ø1.0 L=6mm*11, 6PCS			
G	PE BAG 80*100*0.05MM, 1PCS			
F	RCA FEMALE SOLDERING,WASHER:RED,BLUE,GREEN,CONN:G/F,SHELL:NICEL, 3PCS			
E	OUTSIDE MOLDING:45P PVC,IN BLACK			
D	INSIDE MOLDING:PE			
C	UL1751 26AWG WIRE,IN BLACK, 6PCS			
B	SCREW:#4-40UNC, 2PCS			
A	DVI-(24+5) MALE SOLDERING CONNECTOR,INSULATOR:BLACK,CONN:G/F,SHELL:NICEL,1PCS			
NO	DESCRIPTION	QTY	MATERIAL	PLATING & COLOR
UNLESS OTHERWISE SPECIFIED TOLERANCES				
DECIMALS: ANGLES:				
X	:±0.5	X	:±2°	
X.X	:±0.3	X.X	:±1°	
X.XX	:±0.2			
TITLE DVI-A(12+5) MALE TO RCA FEMALE CABLE				
DWN	REV 2007.3.9	PART NO.	2DS1501-000111	
CHKD	REV 2007.3.9	SCALE:5/4	UNIT: mm	
APVD	ANKEA 2007.3.12	SIZE: A3	SHEET:1 OF 1	REV: B
CUSTOMER COPY				

Singatron Enterprise Co., Ltd.
信音企業股份有限公司