

REV. ECN NO OR DESCRIPTION	REVISED	DATE
A PDR RELEASE	AMVC	2009.08.26

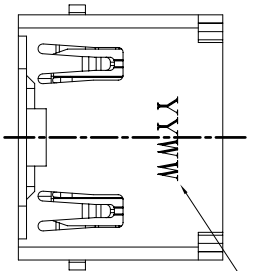

DATE CODE:  
YYMM  
YY(YEAR)(08-~)  
MM(WEEK)(01~52)

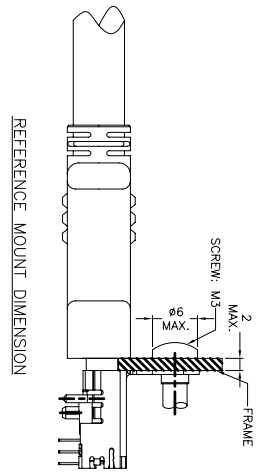

REFERENCE MOUNT DIMENSION

- SPECIFICATIONS:
1. OTHER GENERAL SPEC. TO REFER "HDMI SERIES SPEC."
  2. TO CONFORM TO SINGATRON HAZARDOUS SUBSTANCE FREE SPEC.
  3. PACKAGE : SEE "2HE-5119 SERIES" PACKAGE.
  4. GREEN PRODUCT IDENTIFICATION LABEL ON PACKAGING: **G-P PASS**
  5. FOR REFLOW SOLDERING LEAD-FREE PROCESS.

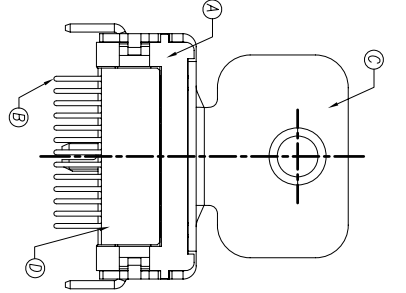
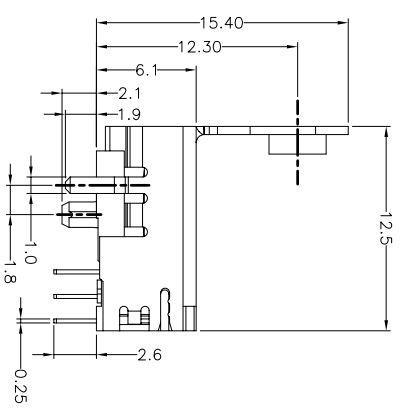
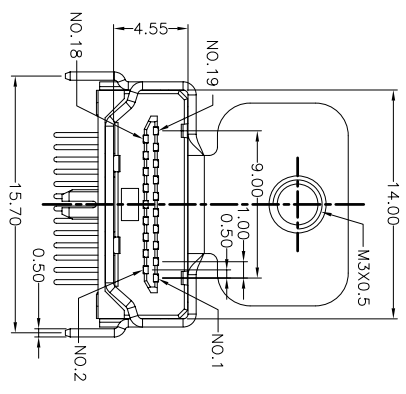

PART NO.  
2HE-5119-002

SHELL CONSTRUCTION  
0: WITH FLANGE AND WITHOUT TOP SPRING

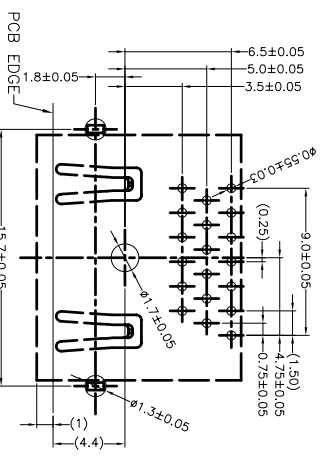
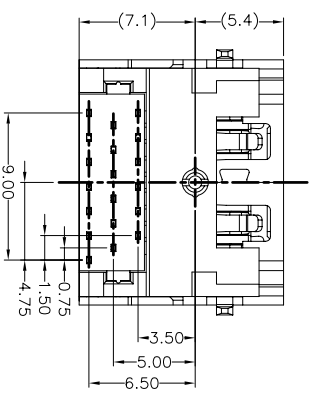

RECOMMENDED PCB LAYOUT  
(THICKNESS=1.6±0.15mm)

E	INK	1	BLACK
D	COVER	1	LCP UL 94V-0 BLACK COLOR
C	SHELL	1	PHOSPHOR BRONZE NICKEL PLATING
B	CONTACT	19	BRASS_C2680
A	HOUSING	1	LCP UL 94V-0
NO	DESCRIPTION	QTY	MATERIAL PLATING & COLOR

UNLESS OTHERWISE SPECIFIED TOLERANCES

DECIMALS: ANGLES:

X : ±0.5 X : ±2°  
X.X : ±0.3 X.X : ±1°  
X.XX : ±0.2

TITLE: HDMI RECEPTACLE THROUGH HOLE LOW PROFILE WITH FLANGE  
DWN: AMVC 2009.08.26  
CHKD: JANSUN 2009.08.26  
APVD: JANSUN 2009.08.26

SCALE: N/A UNIT: mm  
SIZE: A3 SHEET: 1 OF 1 REV: A

Singatron Enterprise Co., Ltd.  
信音企業股份有限公司

CUSTOMER COPY