

REV: A	EGN NO OR DESCRIPTION PRODUCT RELEASE	REVISED XinChoo	DATE 2009.06.27
--------	--	--------------------	--------------------

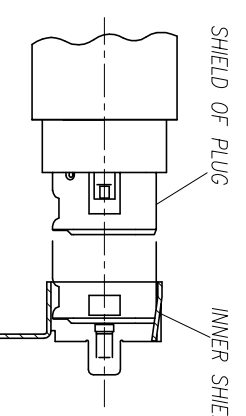

- NOTES:
1. SOLDERING CONDITION: WAVE SOLDERING.
 2. MARKING: MARK "S" ON REAR OF CONNECTOR.
 3. GREEN PRODUCT IDENTIFICATION MARK ON JACK: [G.P. PASS]
 4. GREEN PRODUCT IDENTIFICATION LABEL ON PACKAGING: [G.P. PASS]
 5. TO CONFORM TO SINGATRON HAZARDOUS SUBSTANCE FREE SPEC.
 6. FOR WAVE SOLDERING LEAD-FREE PROCESS.
 7. MATING TO A CUSTOMIZED PLUG.
 8. RATING: PIN 1 AND PIN 2, 48 V DC AT 1.67A
PIN 3 AND PIN 4, 48 V DC AT 1.67A
 9. OTHER GENERAL SPEC. TO REFER "2MJ-0402 SERIES SPEC".
 10. PRINTED DATE CODE "YMMDD" ON TOP OF CONNECTOR.

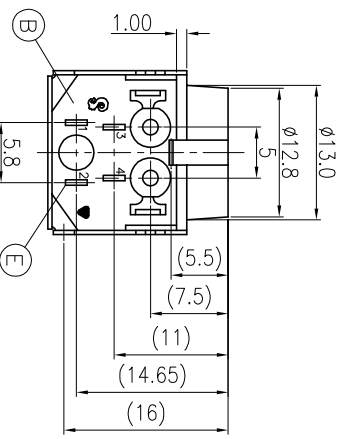
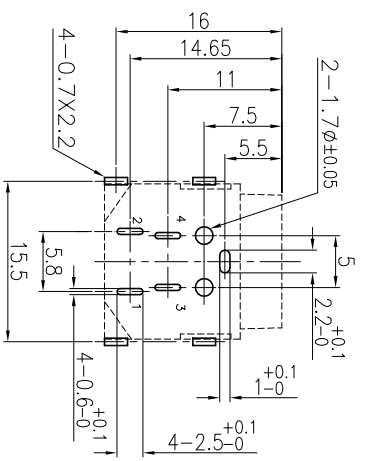
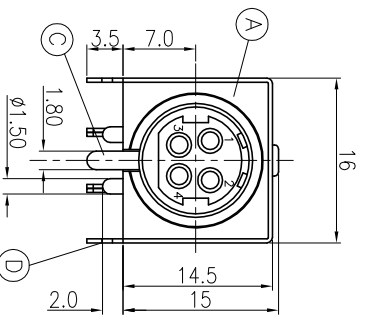
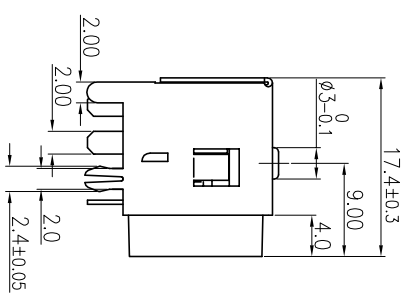
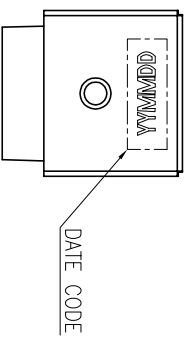
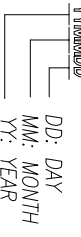

E	CONTACT TERMINAL	4	PHOSPHOR BRONZE 0.3T	SILVER PLATING
D	OUTER SHIELD	1	BRASS 0.4T	TIN ALLOY PLATING
C	INNER SHIELD	1	BRASS 0.4T	NICKEL PLATING
B	COVER	1	THERMOPLASTIC UL94V-0	BLACK COLOR
A	BODY	1	THERMOPLASTIC UL94V-0	BLACK COLOR
NO	DESCRIPTION	QTY	MATERIAL	PLATING & COLOR

UNLESS OTHERWISE SPECIFIED TOLERANCES

Singatron Enterprise Co., Ltd.
信登企業股份有限公司

RECOMMENDED PCB LAYOUT
(TOP VIEW)(TOL. ±0.05)

DECIMALS:		ANGLES:	
X	:±0.5	X	:±2°
X.X	:±0.3	X.X	:±1°
X.XX	:±0.2		
TITLE 4P SOCKET			
DWN	XinChoo	PART NO.	2MJ-0402-014
CHKD	RYAN	SCALE	2:1
APVD	ROBIN	SIZE	A3
		SHEET	10F1
		REV	A

CUSTOMER COPY

