

REV. A	ECN NO. OR DESCRIPTION	REVISED	DATE
	PDR RELEASE	AM/C	2009.06.11

PRINT P/N  
 & DATE CODE  
 YY WW Yf  
 YY: YEAR (08~)  
 WW: WEEK (0~52)  
 Yf: 産線別

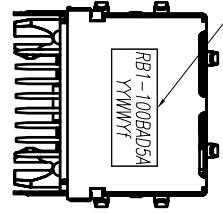

- SPECIFICATIONS:
- OTHER GENERAL SPEC. TO REFER "2TJ1532 SERIES SPEC".
  - TO CONFORM TO SINGATRON HAZARDOUS SUBSTANCE FREE SPEC.
  - FOR WAVE SOLDERING LEAD-FREE PROCESS.
  - GREEN PRODUCT IDENTIFICATION LABEL ON PACKAGING: **G.P. PASS**
  - PACKAGE : SEE "2TJ1516 SERIES" PACKAGE

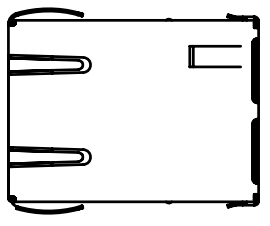
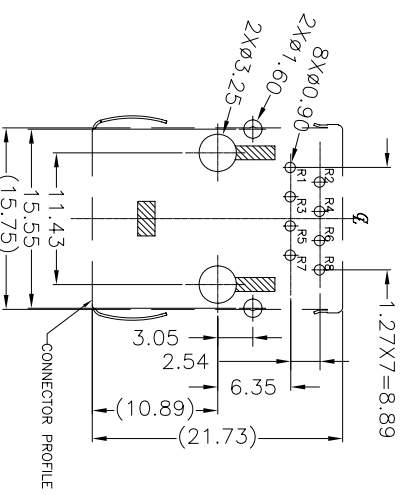
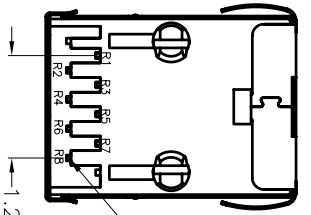
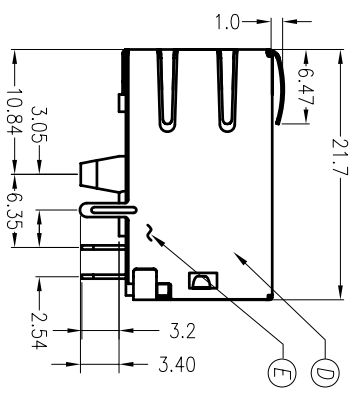
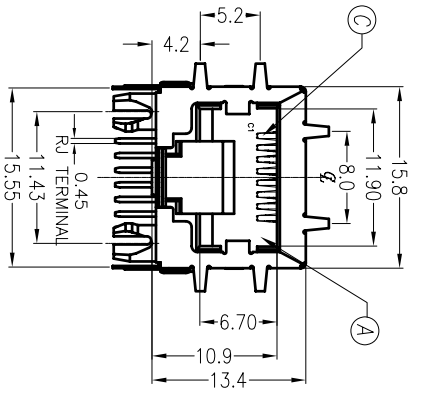

RECOMMENDED PCB LAYOUT  
 COMPONENT SIDE  
 ALL DIMENSION TOLERANCE ARE ±0.05mm  
 UNLESS OTHERWISE SPECIFIED

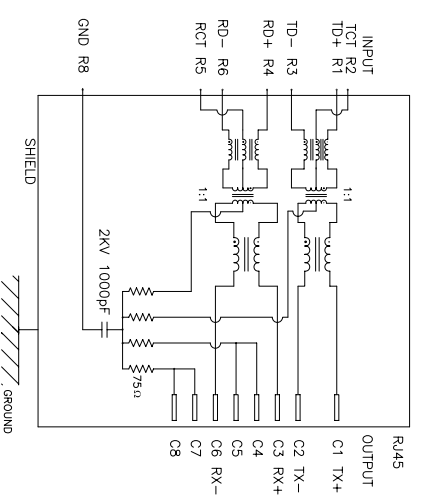

PART NO. 2TJ1532-000111  
 PACKAGE 1: TRAY  
 HOUSING COLOR 1: BLACK  
 CONTACT PLATING 1: Au / TIN

E	PCB	1	PCB	
D	SHELL	1	SUS304	TIN PLATING
C	OUTPUT CONTACT	1	BRASS (C5210)	AU PLATING
B	INPUT CONTACT	1	BRASS (C2680)	TIN PLATING
A	HOUSING	1	PART	BLACK COLOR
NO	DESCRIPTION	QTY	MATERIAL	PLATING & COLOR

UNLESS OTHERWISE SPECIFIED TOLERANCES

DECIMALS:	ANGLES:
X : ±0.5	X : ±2°
X.X : ±0.3	X.X : ±1°
X.XX : ±0.2	

TITLE	RJ45 1X1 w/Transformer
DWG	AMC 2009.06.11
CHKD	AMC 2009.06.11
APVD	AMC 2009.06.11
PART NO.	2TJ1532-000111
SCALE	EN/A
UNIT	mm
SIZE	A3
SHEET	1 OF 1
REV	A

CUSTOMER COPY

Singatron Enterprise Co., Ltd.  
 信登企業股份有限公司

