

REV/ECN	NO OR DESCRIPTION	REVISED	DATE
A	PDR RELEASE	LULU	2007.06.05

Specifications

1. Voltage Rating: 30V AC/DC.
2. Current Rating: 0.3A/PIN.
3. Operating Temperature: -30~+80°.
4. Mating Force: 1.8Kgf Max.
5. Un-Mating Force: 0.8-1.8Kgf.
6. Durability: 10,000 cycles.
7. TO CONFORM TO THE "SE-01-001" & "ROHS DIRECTIVE"
8. GREEN PRODUCT IDENTIFICATION LABEL IN PACKING: **GR-PASS**
9. SOLDER HEAT RESISTANCE : 250°C 10 SECS.
10. SEE "2UP-1517 SERIES SPECIFICATION".

MATTON CONDITION(REFERENCE)

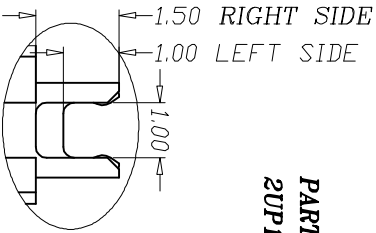
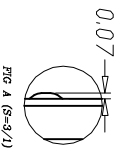
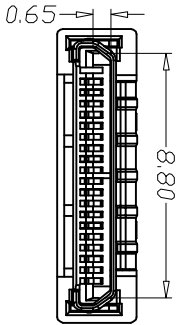
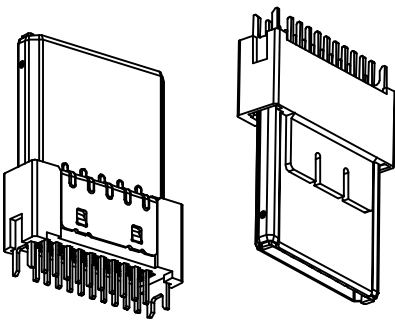
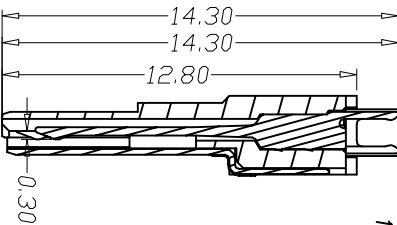
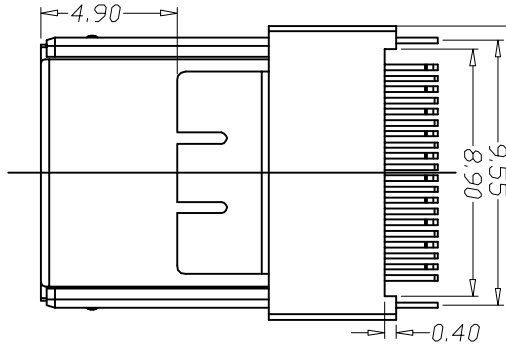
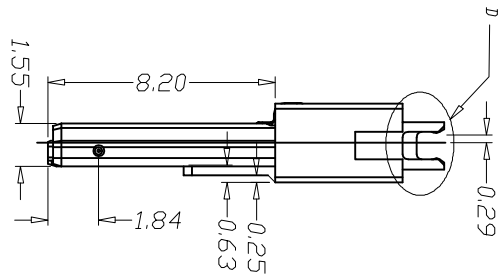
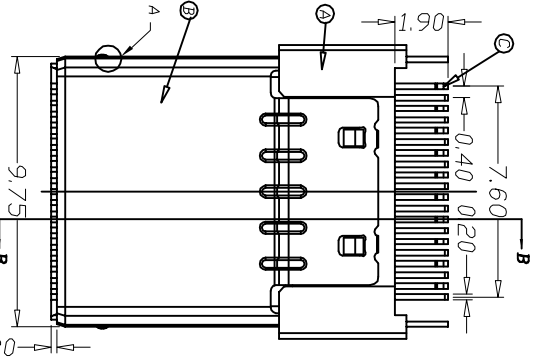
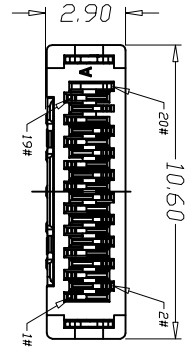
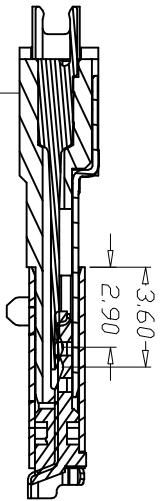

PART NO.
2UP1517-000311

- PACKAGE
- TRAY
- BODY COLOR
- BLACK
- CONTACT PLATING
- 15u" GOLD PLATED

C	CONTACT	20	PHOSPHOR BRONZE 0.12t	15u" GOLD FLASH ON CONTACT AREA GOLD FLASH ON SOLDER AREA OVER NICKEL PLATED(50u" MIN)
B	SHIELDING	1	STAINLESS STEEL 0.2t	
A	HOUSING	1	PA-66 UL94V-0	BLACK COLOR
NO	DESCRIPTION	QTY	MATERIAL	PLATING & COLOR
UNLESS OTHERWISE SPECIFIED TOLERANCES				
DECIMALS:		ANGLES:		
X	:±0.5	X	:±2°	
X.X	:±0.3	X.X	:±1°	
X.XX	:±0.2			
TITLE: MINI MALE 20PIN				
DWG: LULU 2007.66				
CHKD: BEN 2007.66				
APVD: MEBU 2007.66				
SCALE: 2/1 UNIT: mm				
SIZE: A3 SHEET: 1 OF 1				
REV: A				
CUSTOMER COPY				

Singatron Enterprise Co., Ltd.
信音企業股份有限公司