

REV.	ECN NO OR DESCRIPTION	REVISED	DATE
A	PDR NO: T200817-4A	Springwu	2021.4.8

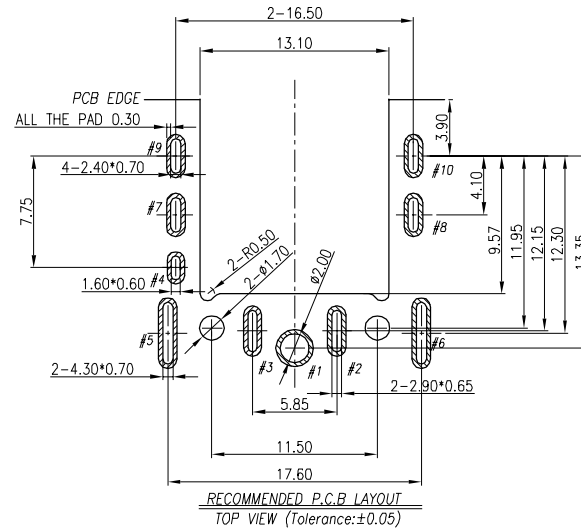

SPECIFICATIONS:

- ELECTRICAL CHARACTERISTICS:
 - RATING: DC 20V 20A.
 - CONTACT RESISTANCE: 10mΩ MAX.(INITIAL)(ONLY FOR PIN+&SPRING-).
CONTACT RESISTANCE: 30mΩ MAX.(INITIAL)(ONLY FOR DETECT).
 - DIELECTRIC WITHSTANDING VOLTAGE: 550V AC FOR ONE MINUTE.
 - INSULATION RESISTANCE: 100MΩ MIN. MEASURED BY 500 VDC
- MECHANICAL CHARACTERISTICS:
 - INSERTION FORCE: 0.8~3.0 Kgf (INITIAL&AFTER LIFE TEST).
 - WITHDRAWAL FORCE: 0.8~3.0 Kgf (INITIAL&AFTER LIFE TEST).
- LIFE TEST: 5,000 CYCLES.
- OTHER GENERAL SPEC. TO REFER "2DC3215-000111F SPEC".
- TO CONFORM TO SINGATRON HAZARDOUS SUBSTANCE FREE SPEC.
- HALOGEN FREE PRODUCT IDENTIFICATION MARK ON JACK: ☉
- HALOGEN FREE PRODUCT IDENTIFICATION LABEL ON PACKAGING: ♻️
- FOR IR REFLOW SOLDERING LEAD-FREE PROCESS.

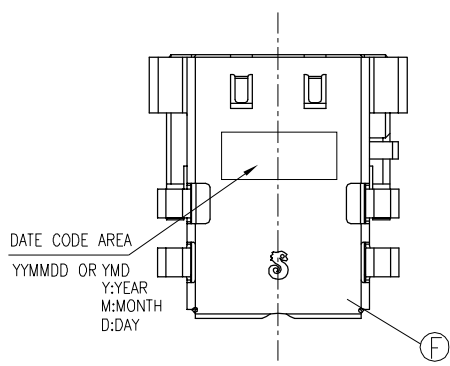
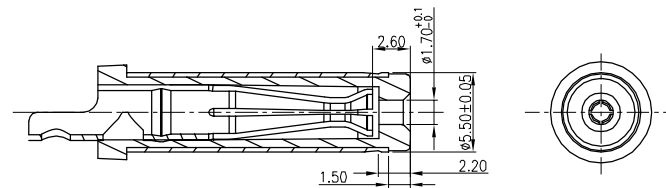
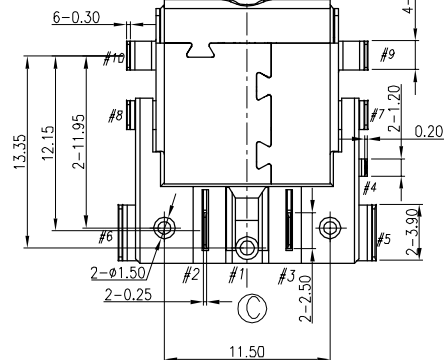
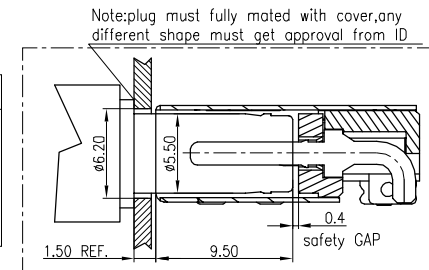
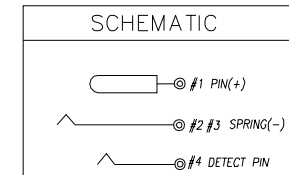
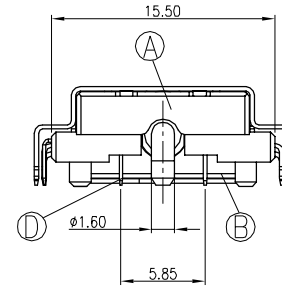
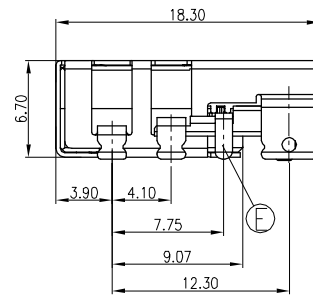
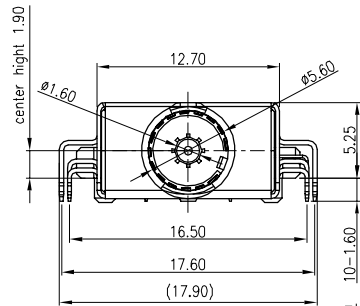

F	SHIELDING	1	STAINLESS 0.3T	Ni 60u" Min..
E	DETECT PIN	1	OPPER ALLOY 0.2T	
D	SPRING(-)	1	COPPER ALLOY 0.25T	GOLD FLASH , OVER Ni 60u" Min..
C	PIN(+)	1	BRASS	
B	BODY BASE	1	HIGH TEMP.THERMOPLASTIC (HALOGEN FREE)UL 94V-0	BLACK
A	BODY TOP	1		
NO	DESCRIPTION	QTY	MATERIAL	PLATING & COLOR
UNLESS OTHERWISE SPECIFIED TOLERANCES			Singatron Enterprise Co., Ltd. 信音企業股份有限公司	
DECIMALS:		ANGLES:	TITLE: DC POWER JACK	
X	:±0.5	X	:±2°	DWN Springwu PART NO. 2DC3215-000111F
X.X	:±0.3	X.X	:±1°	CHKD Sky SCALE 4:1 UNIT: mm
X.XX	:±0.2			APVD Lussen SIZE: A3 SHEET: 1 OF 2 REV:A
CUSTOMER COPY				

REV.	ECN NO OR DESCRIPTION	REVISED	DATE
A	PDR NO: T200817-4A	Springwu	2021.4.8

1. NEGATIVE CONTACT PLUG 插入深度 (4.9)

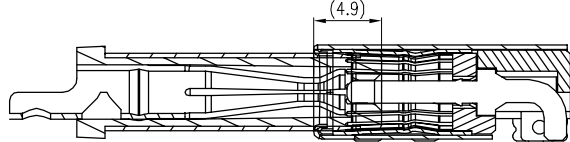

2. POWER PIN(+) CONTACT

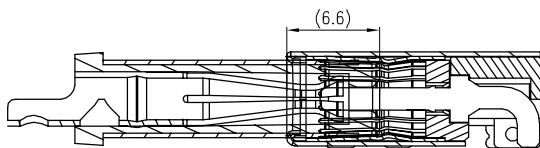

3. DETECT PIN CONTACT

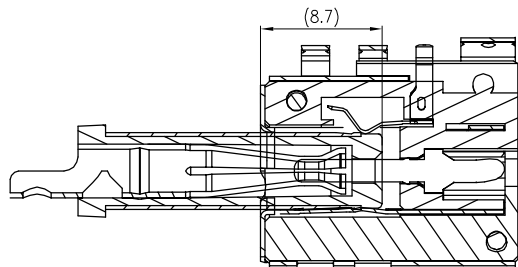

4. LOCKED

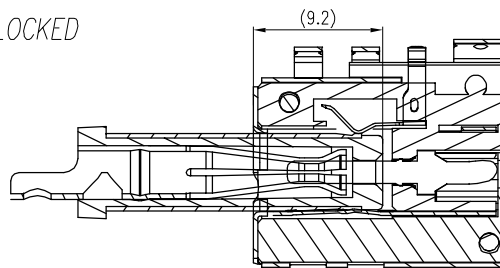

5. FULL MATING

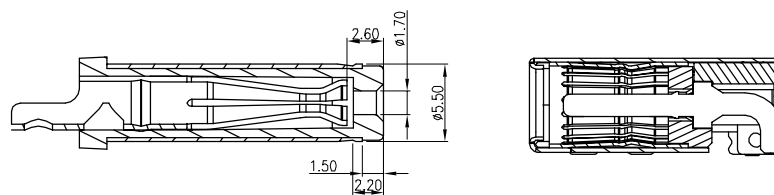
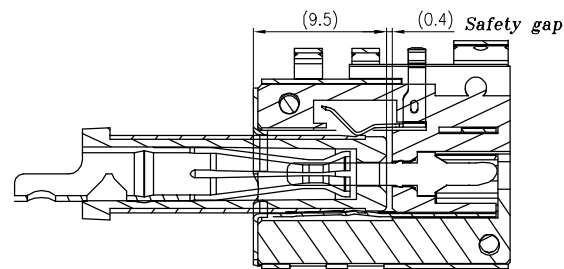

MATING PLUG: 2DP1576-000111F

NO	DESCRIPTION	QTY	MATERIAL	PLATING & COLOR
UNLESS OTHERWISE SPECIFIED TOLERANCES		 Singatron Enterprise Co., Ltd. 信音企業股份有限公司		
DECIMALS:	ANGLES:	TITLE	MATING DRAWING	
X :±0.5	X :±2°	DWN Springwu	PART NO. 2DC3215-000111F	
X.X :±0.3	X.X :±1°	CHKD Sky	SCALE 4:1	UNIT: mm
X.XX :±0.2		APVD Lussen	SIZE: A3	SHEET: 2 OF 2
REV:A				
CUSTOMER COPY				