

REV.	ECN NO OR DESCRIPTION	REVISED	DATE
A	PDR NO. T161104-6A	Springwu	2017.3.20

SPECIFICATIONS:

- ELECTRICAL CHARACTERISTICS:
 - RATING: 20V 8A.
 - CONTACT RESISTANCE: 30mΩ MAX.
 - DIELECTRIC WITHSTANDING VOLTAGE: 500V AC FOR ONE MINUTE.
 - INSULATION RESISTANCE: 100MΩ MIN. MEASURED BY 500 VDC
- MECHANICAL CHARACTERISTICS:
 - INSERTION FORCE: 2.5Kgf Max.
 - WITHDRAWAL FORCE: INITIAL 0.8Kgf MIN.; AFTER LIFE TEST: 0.6Kgf MIN.
- TEMPERATURE RISE CAN'T EXCEED 30°C.
- LIFE TEST: 5,000 CYCLES.
- WEIGHT: 1.17g.
- TO CONFORM TO SINGATRON HAZARDOUS SUBSTANCE FREE SPEC.
- OTHER GENERAL SPEC, PLEASE REFER TO "2DC3069-017114F SPEC".
- HALOGEN FREE IDENTIFICATION MARK ON JACK:
- HALOGEN FREE IDENTIFICATION LABEL ON PACKAGING:
- FOR HAND SOLDERING LEAD-FREE PROCESS.
- PRINTED DATE CODE "YYMMDD" ON TOP OF CONNECTOR.

DD: DAY
MM: MONTH
YY: YEAR

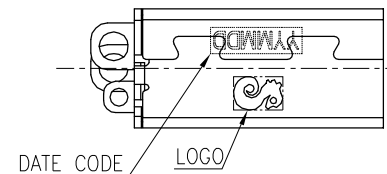

SCHEMATIC	
	#1 SPRING(+)
	#3 SIGNAL
	#2 SPRING(-)

F	SPRING(+)	1	COPPER ALLOY 0.20T	Au5u" over 25u" Pd/Ni on contact;
E	SPRING(-)	1	COPPER ALLOY 0.25T	Matte Sn 120u"Min On Solder;
D	SIGNAL	1	PHOSPHOR BRONZE 0.30T	All Over Ni 50u"Min.
C	SHELL	1	STAINLESS STEEL 0.25T	Ni 50u"Min.
B	COVER	1	THERMOPLASTIC UL 94V-0	BLACK
A	BODY	1	(HALOGEN FREE)	
NO	DESCRIPTION	QTY	MATERIAL	PLATING & COLOR

UNLESS OTHERWISE SPECIFIED TOLERANCES

Singatron Enterprise Co., Ltd.
信音企業股份有限公司

DECIMALS:	ANGLES:	TITLE	DC POWER JACK	
X : ±0.5	X : ±2°	DWN	Springwu	PART NO. 2DC3069-017114F
X.X : ±0.3	X.X : ±1°	CHKD	Sky	SCALE 4:1 UNIT: mm
X.XX : ±0.2		APVD	Lussen	SIZE: A3 SHEET: 1 OF 2 REV:A

CUSTOMER COPY

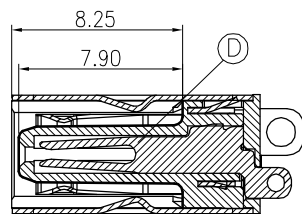
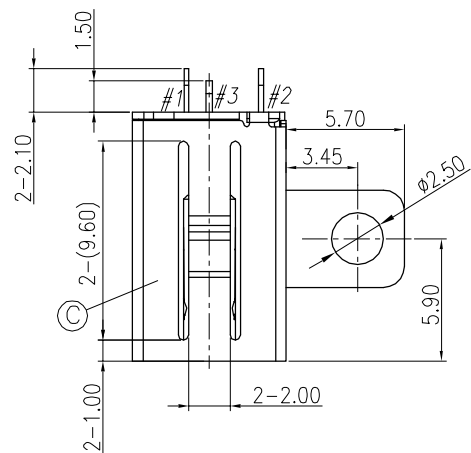

SECTION A-A

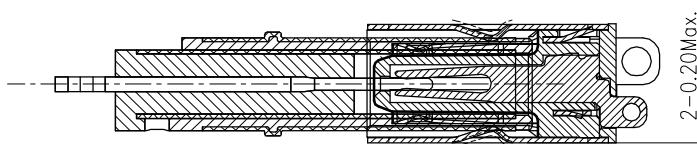
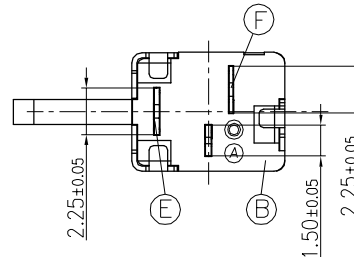
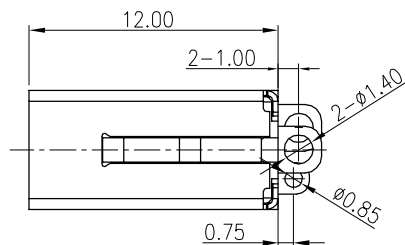
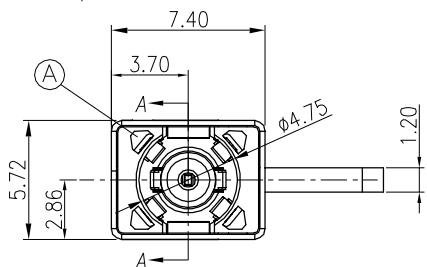
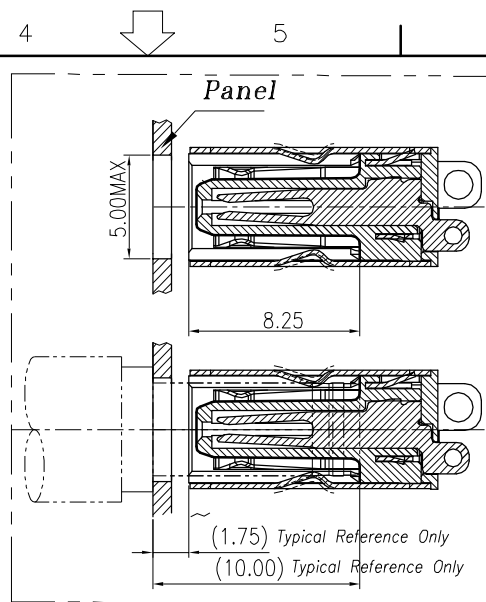

SECTION A-A
PLUG IN

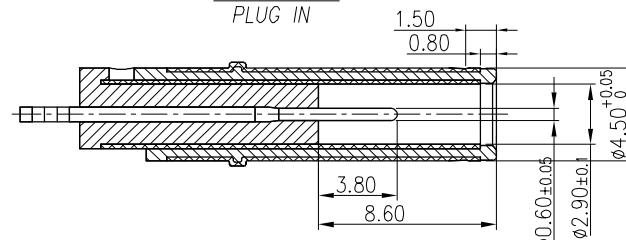

MATING PLUG(FUAN GEE:45P06CV230-1A00-01)
TOLERANCE:X.XX:±0.10

