

REV.	ECN NO OR DESCRIPTION	REVISED	DATE
A	PDR NO.T130910-4A	Springwu	2013.10.14

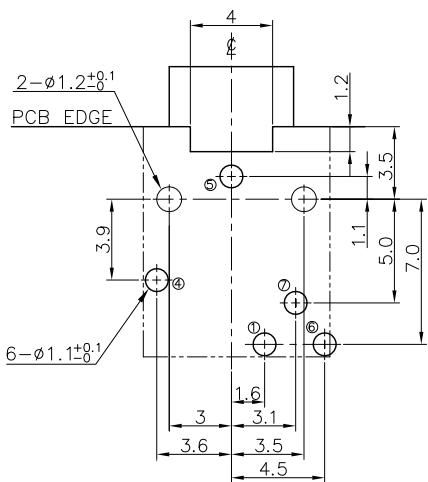

RECOMMEND P.C.B LAYOUT  
<TOP VIEW> TOLERANCE: ±0.05

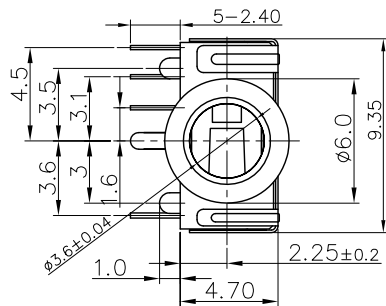
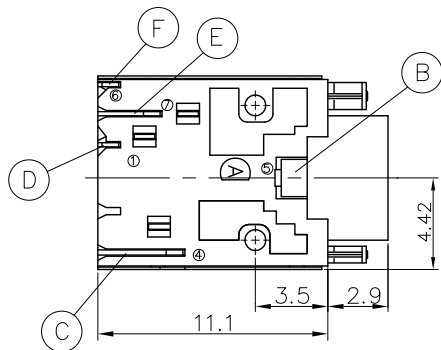
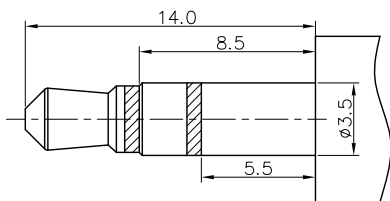
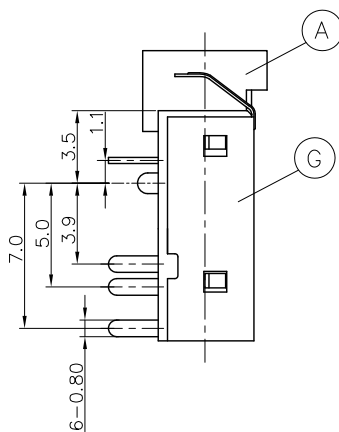

MATING PLUG

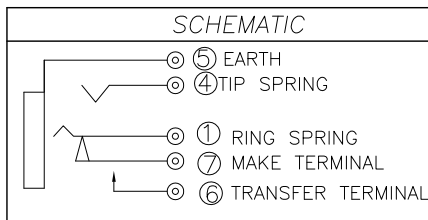
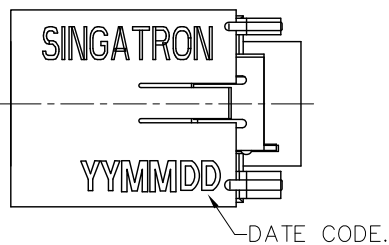

SPECIFICATIONS:

1. ELECTRICAL CHARACTERISTICS:

- 1-1. RATING: 12V 1A
- 1-2. CONTACT RESISTANCE: 30mΩ MAX.(INITIAL)
- 1-3. DIELECTRIC WITHSTANDING VOLTAGE: 500V AC FOR ONE MINUTE.
- 1-4. INSULATION RESISTANCE: 100MΩ MIN. MEASURED BY 500 VDC

2. MECHANICAL CHARACTERISTICS:

- 2-1. INSERTION FORCE : 0.3~3.0 KGF
- 2-2. WITHDRAWAL FORCE : 0.3~3.0 KGF

3. LIFE TEST: 5,000 CYCLES .

4. TO CONFORM TO SINGATRON HAZARDOUS SUBSTANCE FREE SPEC.

5. HALOGEN FREE PRODUCT IDENTIFICATION MARK ON PRODUCT: ☉

6. HALOGEN FREE PRODUCT IDENTIFICATION LOGO ON PACKAGING: ♻️

7. FOR REFLOW SOLDERING LEAD-FREE PROCESS.

8. PLEASE PUT THE PRODUCT IN A CONDITION WHERE IS FULL OF NITROGEN WHEN PASS THE IR REFLOW

NO	DESCRIPTION	QTY	MATERIAL	PLATING & COLOR
G	SHIELDING	1	STAINLESS 0.12T	N/A
F	TRANSFER TERMINAL	1	PHOSPHOR BRONZE 0.2T	GOLD FLASH ON CONTACT AREA Sn 120u"MIN ON SOLDER AREA ALL OVER 50u" Ni
E	MAKE TERMINAL	1	PHOSPHOR BRONZE 0.2T	
D	RING SPRING	1	PHOSPHOR BRONZE 0.2T	Ag 20u" OVER Ni 40u"
C	TIP SPRING	1	PHOSPHOR BRONZE 0.25T	
B	EARTH	1	COPPER ALLOY 0.3T	Ag 20u" OVER Ni 40u"
A	BODY	1	HIGH TEMP.THERMOPLASTIC UL 94V-0	BLACK

UNLESS OTHERWISE SPECIFIED TOLERANCES

Singatron Enterprise Co., Ltd.  
信音企業股份有限公司

DECIMALS: ANGLES:  
X :±0.5 X :±2°  
X.X :±0.3 X.X :±1°  
X.XX :±0.2

TITLE	φ3.5 PHONE JACK		
DWN	Springwu	PART NO. 2SJ-S351-095F	
CHKD	Sky	SCALE:4:1	UNIT: mm
APVD	Lussen	SIZE: A3	SHEET:1 OF 1

CUSTOMER COPY