

REV.	ECN NO OR DESCRIPTION	REVISED	DATE
A	PDR NO.:T09012015X	Steve	2009.01.08
B	ECN NO:S130338	Harlen	2013.3.27

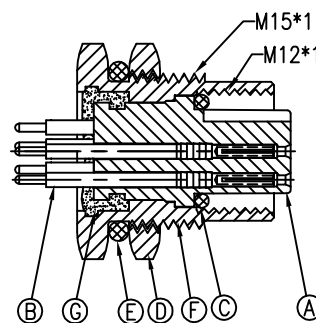

SECTION A-A

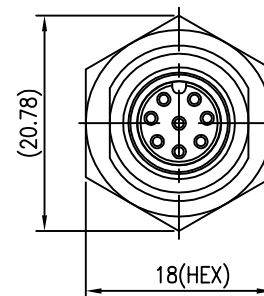
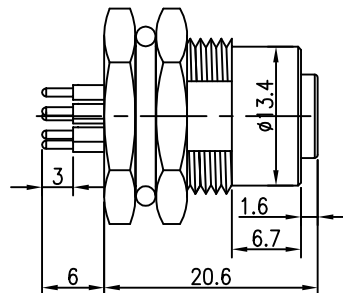
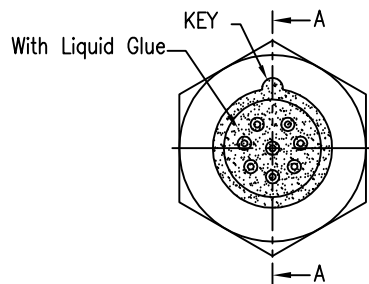
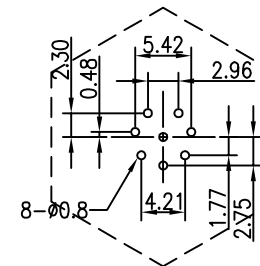

8Pin Female Connector  
Female Pin PCB Layout

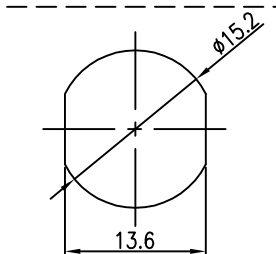

Recommend Panel Cut-out

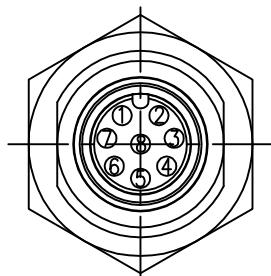

Pin Assignments  
Front View

NOTES:

1. WATERPROOF RATE: IP68  
IP68: IMMERSED IN 1M WATER FOR 24 HOURS
2. ELECTRICAL CHARACTERISTICS  
TEMPERATURE RANGE: -40°C TO +100°C  
RATING: 60V AC/DC 2A  
DIELECTRIC WITHSTANDING VOLTAGE: 500V AC FOR ONE MINUTE
3. SPECIFICATIONS:SEE "M12 SERIES SPECIFICATIONS".
4. TO CONFORM TO SINGATRON HAZARDOUS SUBSTANCE FREE SPEC.
5. GREEN PRODUCT IDENTIFICATION LABEL ON PACKAGING: **G.P. PASS**
6. FOR PANEL THICKNESS MAX OF 4.0mm

G	LIQUID GLUE	1		BLACK
F	SHIELD	1	BRASS	NICKEL PLATING 100u"
E	O-RING	1	EPDM	BLACK
D	NUT	1	BRASS	NICKEL PLATING 100u"
C	O-RING	1	VITON	RED
B	FEMALE PIN	8	Phosphor Bronze Alloy	6u" GOLD PLATED OVER NICKEL PLATING
A	BODY	1	NYLON+33%GF	BLACK
NO	DESCRIPTION	QTY	MATERIAL	PLATING & COLOR
UNLESS OTHERWISE SPECIFIED TOLERANCES			Singatron Electronic(China) Co., Ltd. 信音電子(中國)股份有限公司	
DECIMALS:		ANGLES:		TITLE
X	:±0.5	X	:±2°	M12 SERIES FRONT MOUNT FEMALE CONN.(8PIN) HEXAGONAL BACKSHELL
X.X	:±0.3	X.X	:±1°	DWN Harlen <b>PART NO.2MT3004-X08200</b>
X.XX	:±0.2			CHKD James SCALE 2:1 UNIT: mm
				APVD Steve SIZE: A3 SHEET:1 OF 1 <b>REV: B</b>
<b>CUSTOMER COPY</b>				