

## SGConn® Circular Quick-Lock Connectors

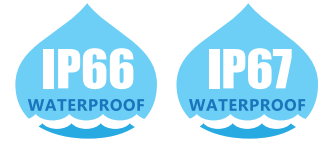

### Introduction

SGConn® Quick-Lock Connectors are manufactured from high grade neoprene with bulkhead bodies and is available with multiple contacts rated up to 500 V/ 1Minutes, depending on the contact configuration. These series meet waterproof rating from IP66 to IP67 in IEC60529 standard.

- ✔ Push lock and Quick release
- ✔ IP66/67 Waterproof Protection
- ✔ Reliable connection exceeded 3,000 times

### Manufacturer Identifications by Panel Cut out

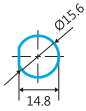

Circular Standard Size  
Hook Lock/ Push Lock  
2HT3XXX/ 2QT3XXX

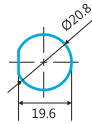

Circular Middle Size  
Push Lock  
2QM3XXX

### Installation Styles



Panel Mount  
■ Solder Pin  
■ PCB Pin

Molded with Cable  
■ Push Lock & Hook Lock

Field Installable  
■ Solder

### Applications

Applications for operating solutions in high altitude, confined space or outdoor conditions as Outdoor Displays and Billboards, AV/ Entertainment Systems, Outdoor signs/ Lighting, Marine solutions, Medical Devices, Testing Measurements, Warning Systems and Spa Equipments.



### Certifications and Membership

SGConn® Circular Connectors are built to the highest quality and specifications and fulfills European Union regulations for RoHS, UL and major worldwide safety requirements.



### Specifications

#### Material

- Contact: Copper Alloy, Gold Plated
- Connector Body: Nylon+ GF, UL Recognized

#### Temperature Range

- Cable: -20°C to +80°C
- Connector Body: -40°C to +105°C

#### IP Rating

- IP66
- IP67

#### Contact Resistance

- ≤30mΩ (without Cable)

#### Insulation Resistance

- ≥100MΩ at DC 500V

#### Durability

- 500 cycles minimum

#### Breakdown Voltage

- ≥AC 500V/ 1 minute

#### Corrosion

- 48 hours salt spray contact



# SGConn® Quick-Lock Connectors

## Pin Configuration

**Current Rating**

○ 5A    ◐ 10A    ● 16A/20A

**Hook Lock Type**

Circular Standard Size  
5A: 4 pins  
10A: 2, 3 pins  
5A+10A: 2+2, 3+2, 4+2 pins

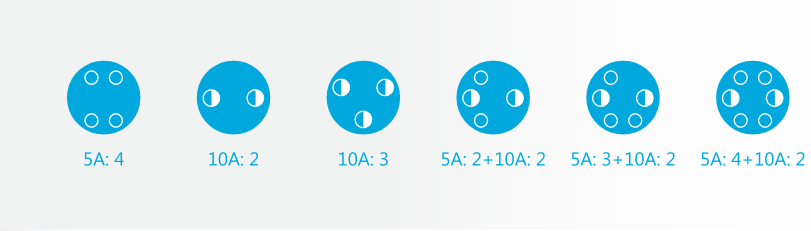

**Push Lock Type**

Circular Standard Size  
5A: 5 pins  
10A: 2, 3, 4 pins  
5A+10A: 4+2 pins

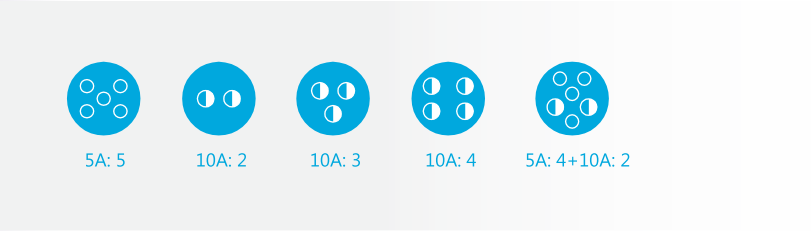

**Push Lock Type**

Circular Middle Size  
5A: 5, 7, 8, 9 pins  
10A: 3, 4 pins  
16A/20A: 2, 3 pins



## Selection Guide



(1) Series No.

**2HT 3XXX**  
**2QT 3XXX**  
**2QM 3XXX**

- **X XX X XX**

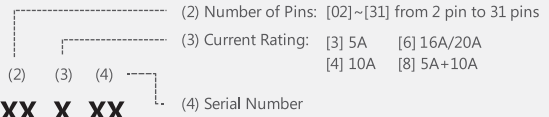

Gender: [M] Male; [F] Female

Series No.	Hook Lock (Circular Standard Size)	Conn.	Pin	Mating Style	Pin Configuration	Mating Parts	Page
<b>2HT3004</b>	Molded with Cable (+SR)	F	F	Hook Lock	5A: 4 pins 10A: 2/3 pins 5A+10A: 2+2/3+2/4+2 pins	2HT3024	<b>B04</b>
<b>2HT3024</b>	Molded with Cable (+SR)	M	M	Hook Lock	5A: 4 pins 10A: 2/3 pins 5A+10A: 2+2/3+2/4+2 pins	2HT3004	<b>B04</b>
<b>2HT303T</b>	Adaptor (T Type)			Hook Lock	5A+10A	--	<b>B05</b>
Series No.	Push Lock (Circular Standard Size)	Conn.	Pin	Mating Style	Pin Configuration	Mating Parts	Page
<b>2QT3002</b>	Panel Mount (180° Solder Type)	M	M	Push Lock	5A: 5 pins 10A: 3/4 pins	2QT3004/3032	<b>B05</b>
<b>2QT3014</b>	Panel Mount (180° Solder Type)	M	F	Push Lock	5A: 5 pins 10A: 2/3 pins 5A+10A: 4+2 pins	2QT3036/3016	<b>B06</b>
<b>2QT3004</b>	Molded with Cable (+SR)	F	F	Push Lock	10A: 4 pins	2QT3002/3024/3033	<b>B06</b>
<b>2QT3016</b>	Molded with Cable (+SR)	F	M	Push Lock	5A+10A: 4+2 pins	2QT3014	<b>B07</b>
<b>2QT3024</b>	Molded with Cable (+SR)	M	M	Push Lock	10A: 4 pins	2QT3004/3032	<b>B07</b>
<b>2QT3032</b>	Field Installable (Solder)	F	F	Push Lock	5A: 5 pins 10A: 3/4 pins	2QT3002/3024	<b>B08</b>
<b>2QT3033</b>	Field Installable (Solder)	M	M	Push Lock	10A: 4 pins	2QT3004/3032	<b>B08</b>
<b>2QT3036</b>	Field Installable (Solder)	F	M	Push Lock	5A: 5 pins 10A: 2/3 pins	2QT3014/3037	<b>B09</b>
<b>2QT3037</b>	Field Installable (Solder)	M	F	Push Lock	5A: 5 pins 10A: 2/3 pins	2QT3036	<b>B09</b>
Series No.	Push Lock (Circular Middle Size)	Conn.	Pin	Mating Style	Pin Configuration	Mating Parts	Page
<b>2QM3002</b>	Panel Mount (180° Solder Type)	M	M	Push Lock	5A: 7/8/9 pins 10A: 3/4 pins 16A/20A: 2/3 pins	2QM3004/3032	<b>B10</b>
<b>2QM3004</b>	Molded with Cable (+SR)	F	F	Push Lock	5A: 7/8/9 pins 10A: 3/4 pins 16A/20A: 2/3 pins	2QM3024/3002/3033	<b>B10</b>
<b>2QM3024</b>	Molded with Cable (+SR)	M	M	Push Lock	10A: 3/4 pins	2QM3004/3032	<b>B11</b>
<b>2QM3032</b>	Field Installable (Solder)	F	F	Push Lock	5A: 5 pins 10A: 3/4 pins 16A/20A: 2/3 pins	2QM3002/3024/3033	<b>B11</b>
<b>2QM3033</b>	Field Installable (Solder)	M	M	Push Lock	5A: 5 pins 10A: 3/4 pins 16A/20A: 2/3 pins	2QM3004/3032	<b>B12</b>

## Hook Lock (Std. Size)

Part No. : 2HT3004

### Molded with Cable [ Female Connector ]

- Mating Style : Hook Lock
- Current Rating : 5A/ 10A/ 5A+10A
- Contact Gender : Female pin
- No. of Contacts : 2-4/ 2+2/ 3+2/ 4+2 pins



**Quick Lock**



### Physical Dimension

Cable OD : Max Ø5.0mm  
Cable Length : Standard 1000mm (L: customized)

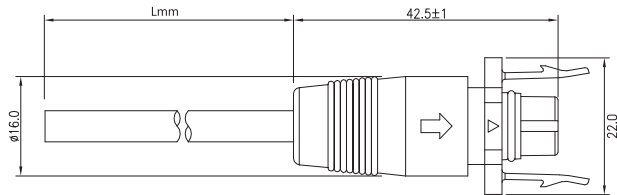

### Pin Configurations and PCB Layouts

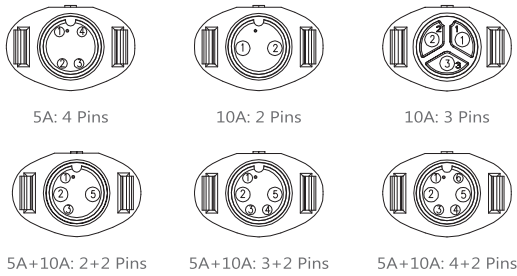

## Hook Lock (Std. Size)

Part No. : 2HT3024

### Molded with Cable [ Male Connector ]

- Mating Style : Hook Lock
- Current Rating : 5A/ 10A/ 5A+10A
- Contact Gender : Male pin
- No. of Contacts : 2-4/ 2+2/ 3+2/ 4+2 pins



**Quick Lock**



### Physical Dimension

Cable OD : Max Ø5.0mm  
Cable Length : Standard 1000mm (L: customized)

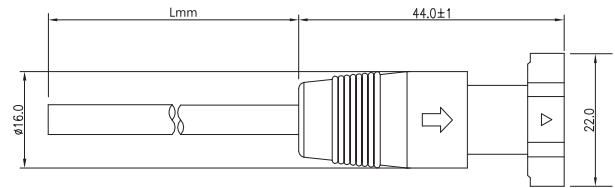

### Pin Configurations and PCB Layouts

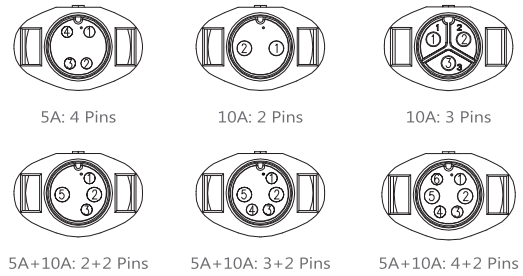

### Mating Parts



2HT3024-XXX30X  
2HT3024-XXX40X  
2HT3024-XXX80X

### Mating Parts



2HT3004-XXX30X  
2HT3004-XXX40X  
2HT3004-XXX80X

## Hook Lock (Std. Size)

Part No. : 2HT303T-X06801

T Adaptor, 5A+10A

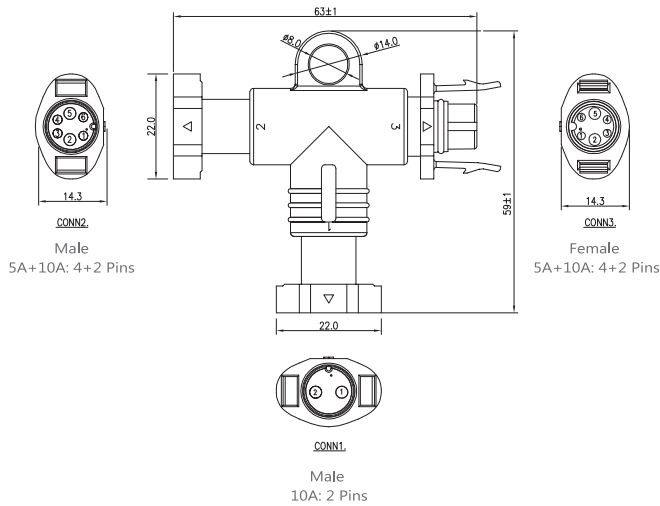

## Push Lock (Std. Size)

Part No. : 2QT3002

Panel Mount Solder Connector [ Male Connector ]

- Mating Style : Push Lock
- Current Rating : 5A/ 10A
- Contact Gender : Male pin
- No. of Contacts : 3/4/5 pins

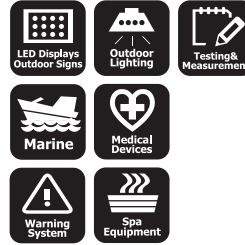

### Physical Dimension

Panel Thickness : Max 4.0mm

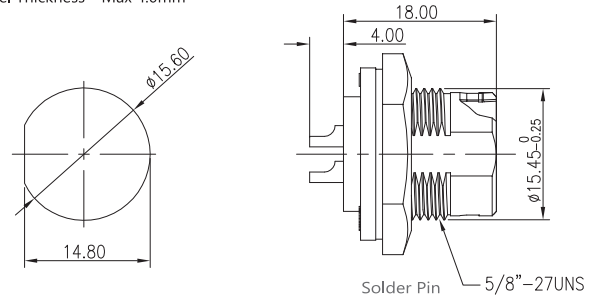

### Pin Configurations and PCB Layouts

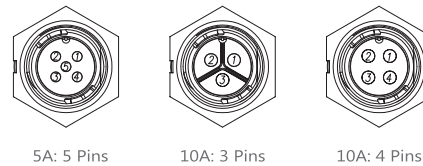

### Mating Parts



2QT3032-X05300  
2QT3032-XXX400



2QT3004-X0440X

## Push Lock (Std. Size)

Part No. : 2QT3014

### Panel Mount Solder Connector [ Male Connector ]

- Mating Style : Push Lock
- Current Rating : 5A/10A/ 5A+10A
- Contact Gender : Female pin
- No. of Contacts : 2/3/5/ 4+2 pins



**Quick Lock**



### Physical Dimension

Panel Thickness : Max 4.0mm

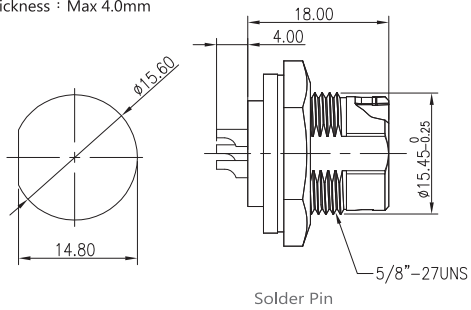

### Pin Configurations and PCB Layouts

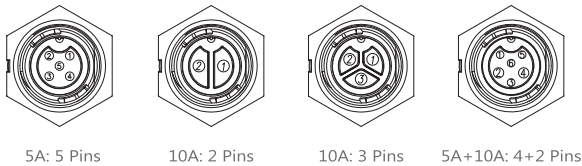

### Mating Parts



2QT3036-X05300  
2QT3036-XXX400

2QT3016-X06800

## Push Lock (Std. Size)

Part No. : 2QT3004

### Molded with Cable [ Female Connector ]

- Mating Style : Push Lock
- Current Rating : 10A
- Contact Gender : Female pin
- No. of Contacts : 4 pins



**Quick Lock**



### Physical Dimension

Cable OD : Max Ø7.5mm

Cable Length : Standard 1000mm (L: customized)

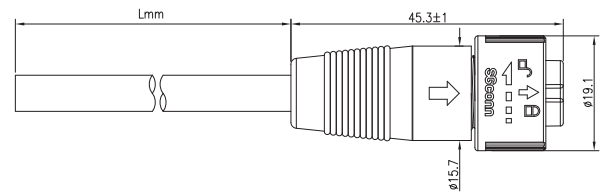

### Pin Configurations and PCB Layouts



### Mating Parts



2QT3024-X0440X

2QT3002-X0440X

2QT3033-X0440X



### Push Lock (Std. Size)

Part No. : 2QT3016

#### Molded with Cable [ Female Connector ]

- Mating Style : Push Lock
- Current Rating : 5A+10A
- Contact Gender : Male pin
- No. of Contacts : 4+2 pins



#### Physical Dimension

Cable OD : Max Ø7.5mm  
 Cable Length : Standard 1000mm (L: customized)

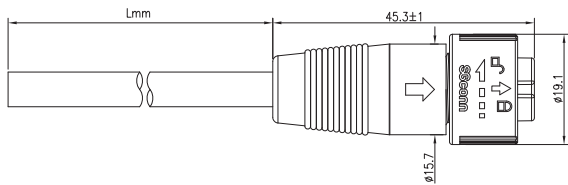

#### Pin Configurations and PCB Layouts



5A+10A: 4+2 Pins

#### Mating Parts



2QT3014-X006800

### Push Lock (Std. Size)

Part No. : 2QT3024

#### Molded with Cable [ Male Connector ]

- Mating Style : Push Lock
- Current Rating : 10A
- Contact Gender : Male pin
- No. of Contacts : 4 pins



#### Physical Dimension

Cable OD : Max Ø7.5mm  
 Cable Length : Standard 1000mm (L: customized)

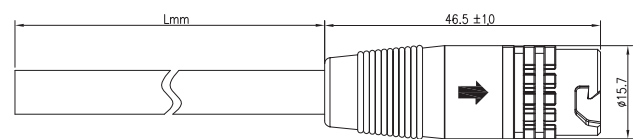

#### Pin Configurations and PCB Layouts

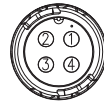

4 Pins

#### Mating Parts



2QT3004-X0440X

2QT3032-X0440X

## Push Lock (Std. Size)

Part No. : 2QT3032

### Field Installable (Solder) [ Female Connector ]

- Mating Style : Push Lock
- Contact Gender : Female pin
- Current Rating : 5A/ 10A
- No. of Contacts : 3/4/5 pins



**Quick Lock**



### Physical Dimension

Cable OD : Ø4.5mm ~ Ø7.0mm

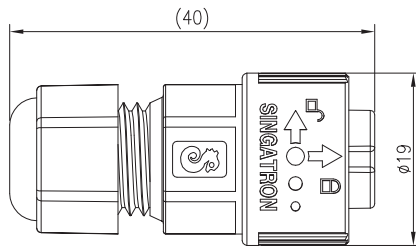

### Pin Configurations and PCB Layouts



5A: 5 Pins



10A: 3 Pins



10A: 4 Pins

## Push Lock (Std. Size)

Part No. : 2QT3033

### Field Installable (Solder) [ Male Connector ]

- Mating Style : Push Lock
- Contact Gender : Male pin
- Current Rating : 10A
- No. of Contacts : 4 pins



**Quick Lock**



### Physical Dimension

Cable OD : Ø4.5mm ~ Ø7.0mm

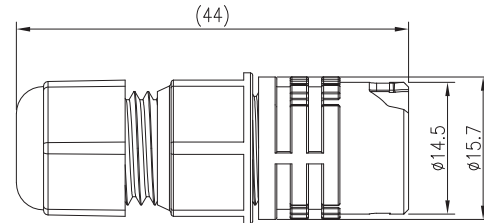

### Pin Configurations and PCB Layouts



4 Pins

### Mating Parts



2QT3002-X05300  
2QT3002-XXX400

2QT3024-XXX40X

### Mating Parts



2QT3032-X04400

2QT3004-X0440X

## Push Lock (Std. Size)

Part No. : 2QT3036

Field Installable (Solder) [ Female Connector ]

- Mating Style : Push Lock
- Current Rating : 5A/ 10A
- Contact Gender : Male pin
- No. of Contacts : 2/3/5 pins



**Quick Lock**



### Physical Dimension

Cable OD : Ø4.5mm ~Ø7.0mm

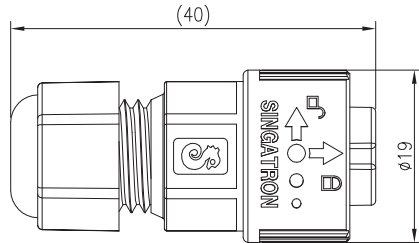

### Pin Configurations and PCB Layouts



5A: 5 Pins



10A: 2 Pins



10A: 3 Pins

## Push Lock (Std. Size)

Part No. : 2QT3037

Field Installable (Solder) [ Male Connector ]

- Mating Style : Push Lock
- Current Rating : 5A/ 10A
- Contact Gender : Female pin
- No. of Contacts : 2/3/5 pins



**Quick Lock**



### Physical Dimension

Cable OD : Ø4.5mm ~Ø7.0mm

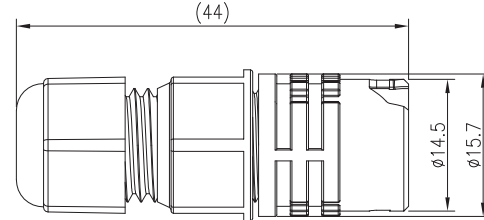

### Pin Configurations and PCB Layouts



5A: 5 Pins



10A: 2 Pins



10A: 3 Pins

### Mating Parts

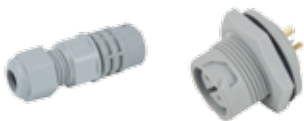

2QT3037-X05300  
2QT3037-XXX400

2QT3014-X05300  
2QT3014-XXX400

### Mating Parts



2QT3036-X05300  
2QT3036-XXX400

## Push Lock (Middle Size)

Part No. : 2QM3002

### Panel Mount Solder Connector [ Male Connector ]

- Mating Style : Push Lock
- Current Rating : 5A/10A/16A/20A
- Contact Gender : Male pin
- No. of Contacts : 2-4/ 7-9 pins



**Quick Lock**



### Physical Dimension

Panel Thickness : Max 3.5mm

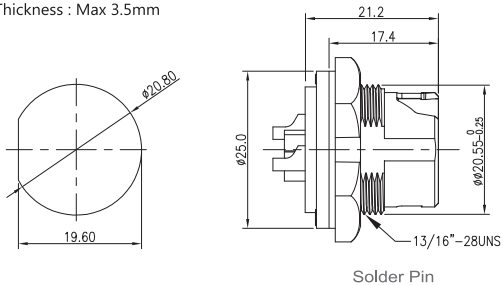

### Pin Configurations and PCB Layouts



5A: 7 Pins

5A: 8 Pins

5A: 9 Pins

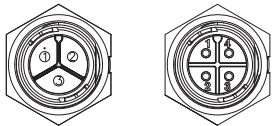

10A: 3 Pins

10A: 4 Pins

### Mating Parts

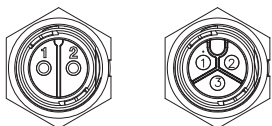

16A/20A: 2 Pins

16A/20A: 3 Pins



2QM3004-XXX300  
2QM3004-X0X40X  
2QM3004-XXX600

2QM3032-XXX400  
2QM3032-XXX600

## Push Lock (Middle Size)

Part No. : 2QM3004

### Molded with Cable [ Female Connector ]

- Mating Style : Push Lock
- Current Rating : 5A/10A/16A/20A
- Contact Gender : Female pin
- No. of Contacts : 2-4/ 7-9 pins



**Quick Lock**



### Physical Dimension

Cable OD : Max Ø10mm

Cable Length : Standard 1000mm (L: customized)

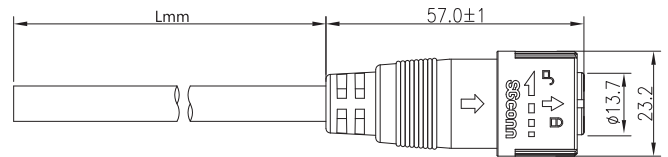

### Pin Configurations and PCB Layouts



5A: 7 Pins

5A: 8 Pins

5A: 9 Pins



10A: 3 Pins

10A: 4 Pins

### Mating Parts

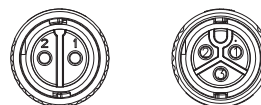

16A/20A: 2 Pins

16A/20A: 3 Pins



2QM3024-X0X40X

2QM3033-XXX600



2QM3002-XXX300  
2QM3002-X0X40X  
2QM3002-XXX600

## Push Lock (Middle Size)

Part No. : 2QM3024

Molded with Cable [ Male Connector ]

- Mating Style : Push Lock
- Contact Gender : Male pin
- Current Rating : 10A
- No. of Contacts : 3/4 pins



**Quick Lock**



### Physical Dimension

Cable OD : Max Ø10mm  
Cable Length : Standard 1000mm (L: customized)

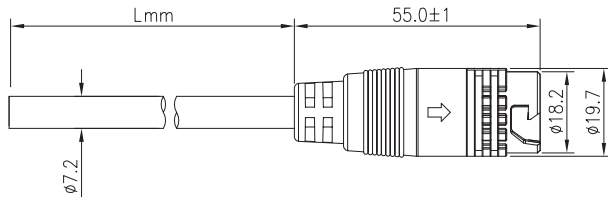

### Pin Configurations and PCB Layouts



10A: 3 Pins

10A: 4 Pins

### Mating Parts



2QM3004-X0340X  
2QM3004-X04400

2QM3032-X0340X  
2QM3032-X04400

## Push Lock (Middle Size)

Part No. : 2QM3032

Field Installable (Solder) [ Female Connector ]

- Mating Style : Push Lock
- Contact Gender : Female pin
- Current Rating : 5A/10A/16A/20A
- No. of Contacts : 2/3/4/5 pins



**Quick Lock**



### Physical Dimension

Cable OD : Ø6.0mm~Ø9.0mm

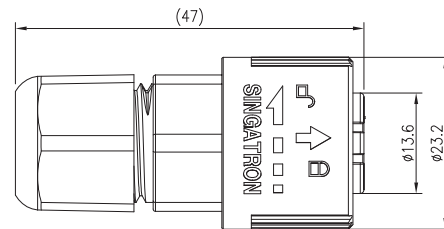

### Pin Configurations and PCB Layouts



5A: 5 Pins

10A: 3 Pins

10A: 4 Pins



16A/20A: 2 Pins

16A/20A: 3 Pins

### Mating Parts



2QM3033-X05300  
2QM3033-X0X400  
2QM3033-X0X600

2QM3024-X0X400  
2QM3024-X0X600



2QM3002-X0X400  
2QM3002-X0X600

## Push Lock (Middle Size)

Part No. : 2QM3033

Field Installable (Solder) [ Male Connector ]

- Mating Style : Push Lock
- Current Rating : 5A/10A/16A/20A
- Contact Gender : Male pin
- No. of Contacts : 2-5 pins



**Quick Lock**



### Physical Dimension

Cable OD : Ø6.0mm~Ø9.0mm

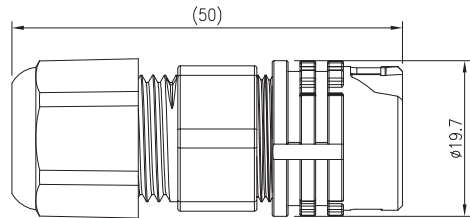

### Pin Configurations and PCB Layouts



5A: 5 Pins



10A: 3 Pins



10A: 4 Pins



16A/20A: 2 Pins



16A/20A: 3 Pins

### Mating Parts



2QM3032-X05300  
2QM3032-X0X400  
2QM3032-X0X600

2QM3004-X0X400  
2QM3004-X0X600



Since 1976  
**SINGATRON GROUP**  
Specialized Connector Manufacturer



✉ sales@singatron.com.tw  
www.singatron.com.tw  
www.singatron.com.cn

● **Taiwan Headquarters**

**Singatron Enterprise Co., Ltd.**

No.209, Sec. 2, Zhongzheng Road, Hukou Township  
Hsinchu County 30343, Taiwan  
Tel +886-3-599 2862 Fax +886-3-599 5601

● **Suzhou, China Plant**

**Singatron Electronic (China) Co., Ltd.**

**Suzhou Singatron Auto Co., Ltd.**

No.509, Xinfeng Road, Xujiang Industrial Park, Xukou Town  
Suzhou City, Jiangsu Province 215164, China  
Tel +86-512-6687 7188 Fax +86-512-6687 7288

● **Zhongshan, China Plant**

**Singatron Electronic (Zhongshan) Co., Ltd.**

Building A1& A3, No.17, Fuze Road, Gaoping Industrial Area, Sanjiao Town  
Zhongshan City, Guangdong Province 528445, China  
Tel +86-760-8540 3451 Fax +86-760-8540 3452

● **Yancheng, China Plant**

**Suzhou Singatron Connector Co., Ltd., Yancheng Branch**

No.8, Qianjin North Road, Bufeng Town Industrial Park, Economic Development Zone  
Yancheng City, Jiangsu Province 224045, China  
Tel +86-515-8882 7860 Fax +86-515-8882 7860-224

**SGconn**<sup>®</sup>  
Waterproof Connectors

Singatron reserves the right to make any changes and updates for design and specification at any time without notice. More information please visit [www.singatron.com.tw](http://www.singatron.com.tw) or contact us.