



SGConn® Circular Connectors

Introduction

SGConn® Circular Connectors are manufactured from high grade neoprene with bulkhead bodies and is available with 1 to 31 contacts rated up to 500 V/ 1Minutes, depending on the contact configuration. These series meet waterproof rating from IP66 to IP68 in IEC60529 standard.

Manufacturer Identifications by Panel Cut out

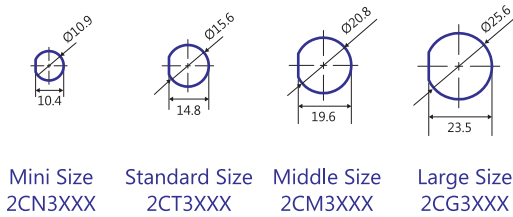

Installation Styles



- Panel Mount**
 - Solder Pin
 - PCB Pin
- Molded with Cable**
 - Screw Type
 - Lock Type
- Field Installable**
 - Solder
- Accessory**
 - Adaptor
 - Cap/ Cover

Applications

Applications for Outdoor Displays and Billboards, AV/ Entertainment Systems, Outdoor signs/ Lighting, PV Solar, Marine solutions, Outdoor AP/ Repeater/ Bridges, Antennas, Base stations and Industrial Automations.



Certifications and Membership

SGConn® Circular Connectors are built to the highest quality and specifications and fulfills European Union regulations for RoHS, UL, VDE and major worldwide safety requirements.



Specifications

Material

- Contact: Copper Alloy, Gold Plated
- Connector Body: Nylon+ GF, PBT, UL Recognized

Temperature Range

- Cable: -20°C to +80°C
- Connector Body: -40°C to +100°C

IP Rating

- IP66
- IP67
- IP68

Contact Resistance

- ≤30mΩ (without Cable)

Insulation Resistance

- ≥100MΩ at DC 500V

Durability

- 500 cycles minimum

Breakdown Voltage

- ≥AC 500V/ 1 minute

Corrosion

- 48 hours salt spray contact

SGConn® Circular Connectors

Pin Configuration



Current Rating



Mini Size

2A: 3-6, 8 pins
5A: 2 pins



Standard Size

2A: 10, 12 pins
5A: 2-8 pins
10A: 2-4 pins
5A+10A: 2+2, 3+2, 4+2 pins
50A: 1 pin

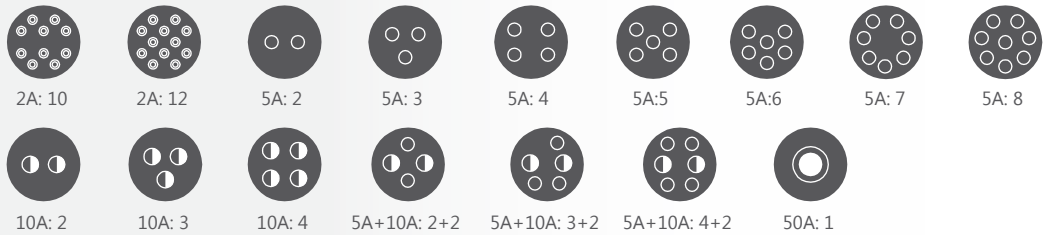

Middle Size

2A: 15, 18 pins
5A: 7-10, 12, 14 pins
10A: 2-6 pins
5A+10A: 3+3 pins
16A: 3 pins
2A+16A: 2+2, 3+2 pins
20A: 3 pins
2A+20A: 7+2 pins
40A: 2 pins

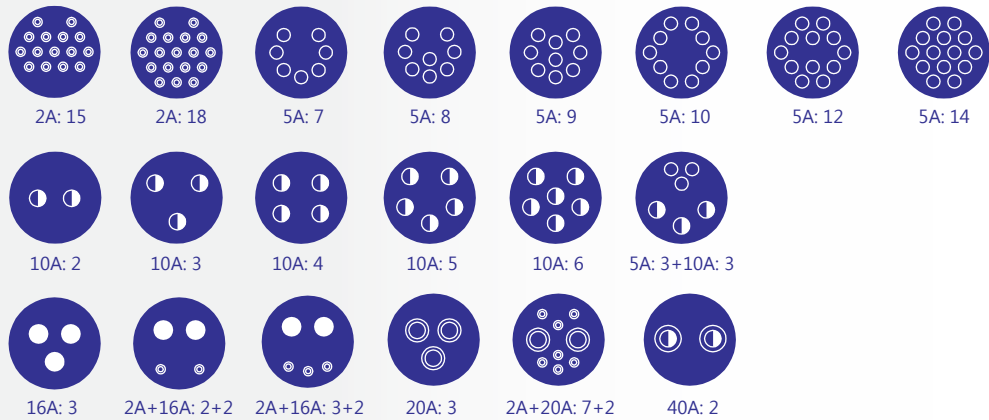

Large Size

5A: 12, 16, 18 pins
20A: 3 pins
5A+20A: 4+2, 9+3 pins
40A: 2 pins

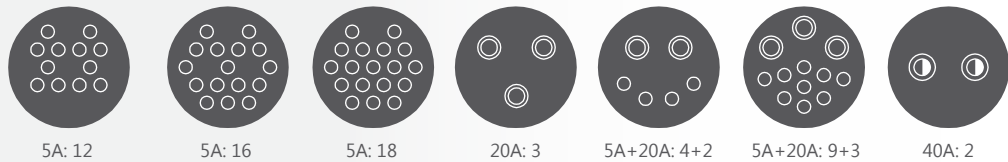



Selection Guide (1/3)

(1) Series No. (2) Number of Pins: [01]~[31] from 1 pin to 31 pins
 (3) Current Rating (4) Serial Number

CN
2 CT 3 XXX - X XX X XX

[1] 1A	[6] 16A/20A	[B] 2A+16A	[G] 40A
[2] 2A	[7] 2A+5A	[C] 15A	[H] 50A
[3] 5A	[8] 5A+10A	[D] 2A+15A	[J] 25A
[4] 10A	[9] 2A+10A	[E] 2A+20A	
[5] 12A	[A] 5A+16A	[F] 5A+20A	

Gender: [M] Male; [F] Female

Series No.	Circular Mini Size	Conn.	Pin	Mating Style	Pin Configuration	Mating Parts	Page
2CN3000	Panel Mount (180° PCB Type)	M	M	Lock	2A: 8 pins	2CN3004/3032	A06
2CN3002	Panel Mount (180° Solder Type)	M	M	Lock	2A: 3/4/5/6/8 pins 5A: 2 pins	2CN3004/3032	A06
2CN3004	Molded with Cable (+SR)	F	F	180° Lock	2A: 4/5/6/8 pins 5A: 2 pins	2CN3000/3002	A06
2CN3032	Field Installable (Solder)	F	F	180° Lock	2A: 3/4/5/6/8 pins 5A: 2 pins	2CN3000/3002	A07
Series No.	Circular Standard Size	Conn.	Pin	Mating Style	Pin Configuration	Mating Parts	Page
2CT3000	Panel Mount (180° PCB Type)	M	M	Lock	2A: 10/12 pins 5A: 4/5/6/7/8 pins 10A: 2/3/4 pins	2CT3004/3010/3032	A08
2CT3002	Panel Mount (180° Solder Type)	M	M	Lock	2A: 10/12 pins 5A: 4/5/6/7/8 pins 10A: 2/3/4 pins	2CT3004/3010/3032	A08
2CT3014	Panel Mount (180° Solder/ Screw Type)	M	F	Lock	5A: 4 pins 10A: 3 pins 5A+10A: 4+2 pins 50A: 1 pins	2CT3016	A09
2CT3020	Panel Mount (180° Solder Type) (Square Backshell)	M	F	Lock	10A: 3 pins 5A+10A: 2+2 pins	2CT3016	A09
2CT3040	Panel Mount+Molded with Cable	M	F	180° Lock	5A: 6 pins	2CT3016	A10
2CT3501	Panel Mount Shielded (180° Solder Type)	M	M	Screw	5A: 8 pins	2CT3505	A10
2CT3004	Molded with Cable (+SR)	F	F	180° Lock	2A: 10/12 pins 5A: 4/5/6/7/8 pins 10A: 2/3/4 pins	2CT3000/3002/3024/3028/3033	A11
2CT3010	Molded with Cable (+SR)	F	F	90° Lock	2A: 10/12 pins 5A: 4/5/6/7/8 pins 10A: 2/3/4 pins	2CT3000/3002/3024/3028/3033	A11
2CT3024	Molded with Cable (+SR)	M	M	180° Lock	2A: 10/12 pins 5A: 4/5/6/7/8 pins 10A: 2/3/4 pins	2CT3004/3010/3032	A12
2CT3028	Molded with Cable (+SR)	M	M	90° Lock	2A: 10/12 pins 5A: 4/5/6/7/8 pins 10A: 2/3/4 pins	2CT3004/3010/3032	A12
2CT3016	Molded with Cable (+SR)	F	M	180° Lock	5A: 4 pins 10A: 3 pins 5A+10A: 2+2/3+2/4+2 pins 50A: 1 pins	2CT3014/3020/3030	A13
2CT3030	Molded with Cable (+SR)	M	F	180° Lock	5A: 4 pins 10A: 3 pins 5A+10A: 2+2/3+2/4+2 pins	2CT3016	A14
2CT3505	Molded with Cable Shielded (+SR)	F	F	180° Screw	5A: 8 pins	2CT3501	A14
2CT3032	Field Installable (Solder)	F	F	180° Lock	2A: 10/12 pins 5A: 2/3/4/5/6/7/8 pins 10A: 2/3/4 pins	2CT3000/3002/3024/3028/3033	A15
2CT3033	Field Installable (Solder)	M	M	180° Lock	2A: 10/12 pins 5A: 2/3/4/5/6/7/8 pins 10A: 2/3/4 pins	2CT3004/3010/3032	A16
2CT303T/3Y	Accessory; Adaptor (T/Y Type)				5A/10A	--	A17
2CT3000/24	Accessory; Waterproof Cap/ Cover				--	--	A17

Selection Guide (2/3)

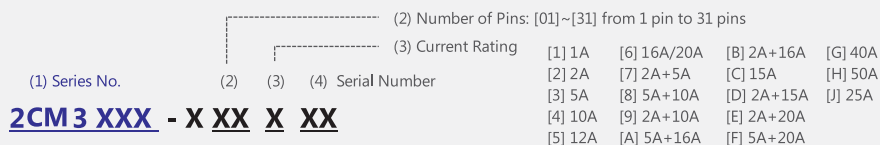

Gender: [M] Male; [F] Female

Series No.	Circular Middle Size	Conn.	Pin	Mating Style	Pin Configuration	Mating Parts	Page
2CM3000	Panel Mount (180° PCB Type)	M	M	Lock	2A: 18 pins 5A: 7/8/9 pins 10A: 4/5/6 pins 16A: 3 pins	2CM3004/3032	A18
2CM3002	Panel Mount (180° Solder Type)	M	M	Lock	2A: 15/18 pins 5A: 7-10/12/14 pins 10A: 3/4/5/6 pins 16A: 3 pins 40A: 2 pins	2CM3004/3032	A18
2CM3012	Panel Mount (180° PCB Type)	M	F	Lock	2A+20A: 7+2 pins 16A: 3 pins	2CM3016	A19
2CM3014	Panel Mount (180° Solder Type)	M	F	Lock	2A+16A: 2+2/3+2 pins 2A+20A: 7+2 pins	2CM3016	A19
2CM3137	Panel (Rear) Mount (180° Solder Type)	M	F	Lock	20A: 3 pins	2CM3036	A20
2CM3040	Panel Mount+Molded with Cable	M	F	180° Lock	5A: 9 pins	2CM3016	A20
2CM3004	Molded with Cable (+SR)	F	F	180° Lock	2A: 15/18 pins 5A: 7-10/12/14 pins 10A: 3/4/5/6 pins 16A: 3 pins 40A: 2 pins 5A+10A: 3+3 pins	2CM3000/3002/3024/3033	A21
2CM3010	Molded with Cable (+SR)	F	F	90° Lock	5A: 7-10/12/14 pins 10A: 3/4/5/6 pins	2CM3000/3002/3024/3033	A21
2CM3016	Molded with Cable (+SR)	F	M	180° Lock	16A: 3 pins 2A+16A: 2+2/3+2 pins 2A+20A: 7+2 pins	2CM3012/3014/3030	A23
2CM3024	Molded with Cable (+SR)	M	M	180° Lock	5A: 7/8/9 pins 10A: 3 pins 5A+10A: 3+3 pins 16A: 3 pins	2CM3004/3032	A22
2CM3030	Molded with Cable (+SR)	M	F	180° Lock	16A: 3 pins 2A+20A: 7+2 pins	2CM3016	A23
2CM3032	Field Installable (Solder)	F	F	180° Lock	5A: 7/8/9 pins 10A: 3/4/5/6 pins 16A: 3 pins 20A: 3 pins	2CM3000/3002/3024/3033/3133	A24
2CM3033	Field Installable (Solder)	M	M	180° Lock	5A: 7/8/9 pins 10A: 3/4/5/6 pins 5A+10A: 3+3 pins 16A: 3 pins 20A: 3 pins	2CM3004/3032	A25
2CM3036	Field Installable (Solder)	F	M	180° Lock	20A: 3 pins 2A+20A: 7+2 pins	2CM3037/3137	A26
2CM3037	Field Installable (Solder)	M	F	180° Lock	20A: 3 pins 2A+20A: 7+2 pins	2CM3036	A26
2CM3000/ /3004/3024	Accessory; Waterproof Cap/ Cover					--	A27



Selection Guide (3/3)

(1) Series No. (2) Number of Pins: [01]~[31] from 1 pin to 31 pins
 (2) (3) (4) Serial Number (3) Current Rating

2 CG 3 XXX - X XX X XX

[1] 1A	[6] 16A/20A	[B] 2A+16A	[G] 40A
[2] 2A	[7] 2A+5A	[C] 15A	[H] 50A
[3] 5A	[8] 5A+10A	[D] 2A+15A	[J] 25A
[4] 10A	[9] 2A+10A	[E] 2A+20A	
[5] 12A	[A] 5A+16A	[F] 5A+20A	

Gender: [M] Male; [F] Female

Series No.	Circular Large Size	Conn.	Pin	Mating Style	Pin Configuration	Mating Parts	Page
2CG3000	Panel Mount (180° PCB Type)	M	M	Lock	5A: 18 pins	2CG3004/3010	A28
2CG3002	Panel Mount (180° Solder Type)	M	M	Lock	5A: 12/18 pins 20A: 3 pins 40A: 2 pins 5A+20A: 9+3 pins	2CG3004/3010	A28
2CG3012	Panel Mount (180° PCB Type)	M	F	Lock	5A: 18 pins	2CG3016	A29
2CG3014	Panel Mount (180° Solder Type)	M	F	Lock	5A: 12/16 pins	2CG3016	A29
2CG3015	Panel Mount (180° Solder Type)	M	F	Screw	5A+20A: 4+2 pins	2CG3017	A29
2CG3037	Panel Mount (180° Solder Type)	F	F	Lock	5A+20A: 9+3 pins	2CG3024	A30
2CG3004	Molded with Cable (+SR)	F	F	180° Lock	5A: 12/18 pins 20A: 3 pins 40A: 2 pins 5A+20A: 9+3 pins	2CG3000/3002/3024	A31
2CG3010	Molded with Cable (+SR)	F	F	90° Lock	5A: 12 pins 40A: 2 pins	2CG3000/3002/3024	A31
2CG3016	Molded with Cable (+SR)	F	M	180° Lock	5A: 12/16/18 pins	2CG3014	A32
2CG3017	Molded with Cable (+SR)	F	M	180° Screw	5A+20A: 4+2 pins	2CG3015	A32
2CG3024	Molded with Cable (+SR)	M	M	180° Lock	5A: 18 pins 5A+20A: 9+3 pins	2CG3004/3037	A33
2CG3000	Accessory; Waterproof Cap					---	A33

Mini Size

Part No. : 2CN3000/ 2CN3002

Panel Mount PCB/ Solder Connector [Male Connector]

- Mating Style : Lock Type
- Contact Gender : Male pin
- Current Rating : 2A, 5A
- No. of Contacts : 2-6/8 pins



PCB Pin
2CN3000
2A : 8 pins



Solder Pin
2CN3002
2A : 3/4/5/6/8 pins

Physical Dimension

Panel Thickness : Max 3.2mm

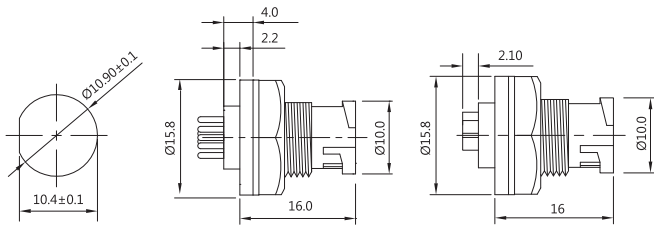

PCB Pin
2CN3000-

Solder Pin
2CN3002-

Pin Configurations and PCB Layouts

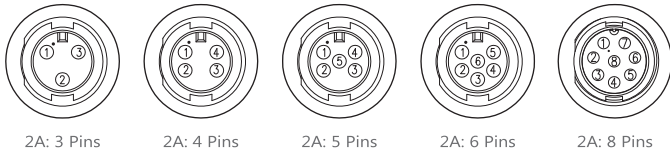

2A: 3 Pins

2A: 4 Pins

2A: 5 Pins

2A: 6 Pins

2A: 8 Pins

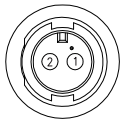

5A: 2 Pins

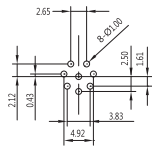

Mating Parts



2CN3032-XXX200
2CN3032-XXX300

2CN3004-XXX200
2CN3004-XXX300

Accessories



2CN3000-X000ADH

Mini Size

Part No. : 2CN3004

Molded with Cable [Female Connector]

- Mating Style : Lock Type
- Contact Gender : Female pin
- Current Rating : 2A/5A
- No. of Contacts : 2/4/5/6/8 pins



Physical Dimension

Cable OD : Max Ø5.0mm

Cable Length : Standard 1000mm (L: customized)

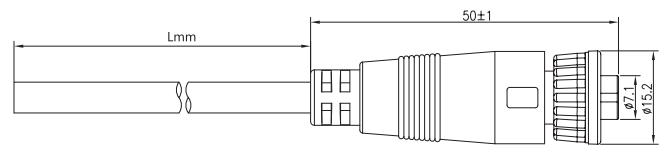

Pin Configurations and PCB Layouts

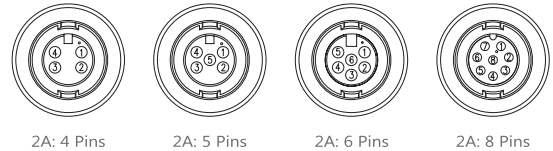

2A: 4 Pins

2A: 5 Pins

2A: 6 Pins

2A: 8 Pins



5A: 2 Pins

Mating Parts



2CN3000-X08200
2CN3002-XXX200/ XXX300



Mini Size

Part No. : 2CN3032

Field Installable (Solder) [Female Connector]

- Mating Style : Lock Type
- Current Rating : 2A/ 5A
- Contact Gender : Female pin
- No. of Contacts : 2-6/ 8 pins



Physical Dimension

Cable OD : Ø4.0mm ~ Ø6.5mm

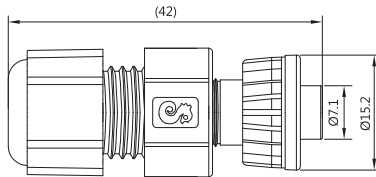

Pin Configurations and PCB Layouts

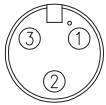

2A: 3 Pins



2A: 4 Pins



2A: 5 Pins



2A: 6 Pins



2A: 8 Pins

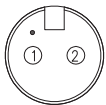

5A: 2 Pins

Mating Parts



2CN3000-X08200
2CN3002-XXX200/XXX300

Accessories



2CN3000-X000ADH

Standard Size

Part No. : 2CT3000/ 2CT3002

Panel Mount PCB/ Solder Connector [Male Connector]

- Mating Style : Lock Type
- Contact Gender : Male pin
- Current Rating : 2A/ 5A/ 10A
- No. of Contacts : 2-8/ 10/ 12 pins



1 PCB Pin 2CT3000- 2 Solder Pin 2CT3002-

Physical Dimension

Panel Thickness : Max 4.0 mm

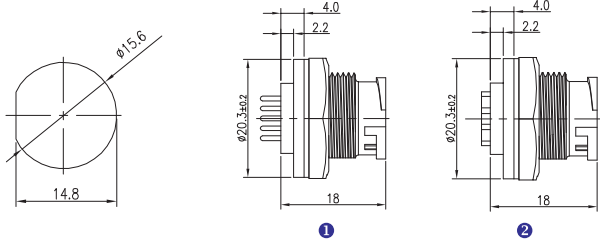

Pin Configurations and PCB Layouts

1 PCB Pin	2 Solder Pin	Rating	No. of Contacts
2CT3000-XXX200	2CT3002-XXX200	2A	10/12 pins
2CT3000-XXX300	2CT3002-XXX300	5A	4/5/6/7/8 pins
2CT3000-XXX400	2CT3002-XXX400	10A	2/3/4 pins

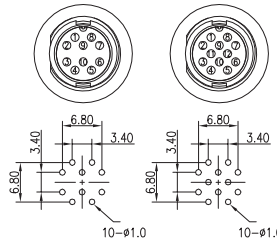

2A: 10 Pins 2A: 12 Pins

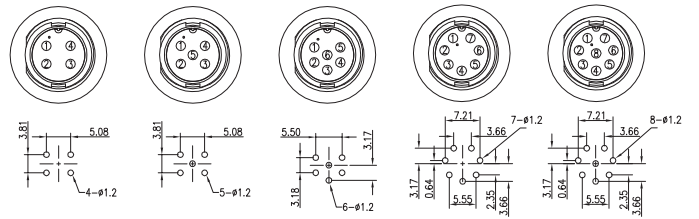

5A: 4 Pins 5A: 5 Pins 5A: 6 Pins 5A: 7 Pins 5A: 8 Pins

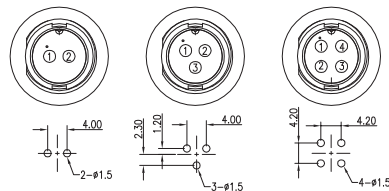

10A: 2 Pins 10A: 3 Pins 10A: 4 Pins

Mating Parts



- 2CT3010-XXX200 2CT3004-XXX200 2CT3032-XXX200
- 2CT3010-XXX300 2CT3004-XXX300 2CT3032-XXX300
- 2CT3010-XXX400 2CT3004-XXX400 2CT3032-XXX400

Accessories



2CT3000-X0000W 2CT3000-X0000D

Standard Size

Part No. : 2CT3014

Panel Mount Solder/Screw Connector [Male Connector]

- Mating Style : Lock Type
- Current Rating : 5A/10A/5A+10A/50A
- Contact Gender : Female pin
- No. of Contacts : 1/3/4/2+4 pins



① Solder Pin



② Screw Pin

Physical Dimension

Panel Thickness : Max 4.0mm

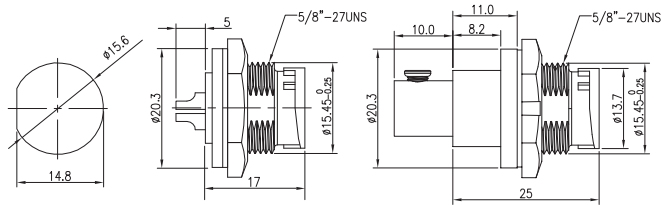

① Solder Pin

② Screw Pin

Pin Configurations and PCB Layouts

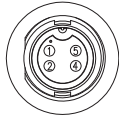

2CT3014-X04300
5A: 4 Pins
①

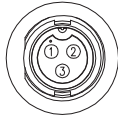

2CT3014-X03400
10A: 3 Pins
①

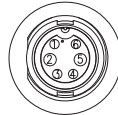

2CT3014-X06800
5A+10A: 4+2 Pins
①

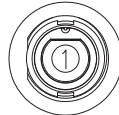

2CT3014-X01H00
50A: 1 Pin
②

Standard Size

Part No. : 2CT3020

Panel Mount Solder Connector [Male Connector]

- Mating Style : Lock Type
- Current Rating : 10A/ 5A+10A
- Contact Gender : Female pin
- No. of Contacts : 3/ 2+2 pins



① 10A: 3 pins



② 5A+10A: 2+2 pins

Physical Dimension

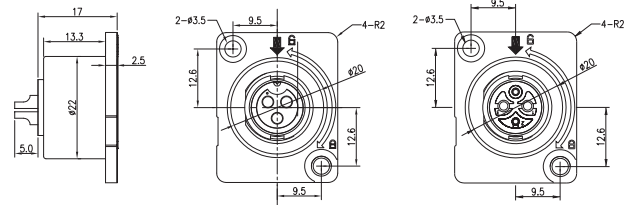

Solder Pin

①

②

Pin Configurations and PCB Layouts

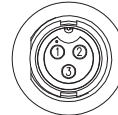

2CT3020-X034A0
10A: 3 Pins
①

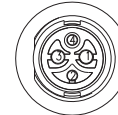

2CT3020-X048A0
5A+10A: 2+2 Pins
②

Mating Parts



① 2CT3016-X0430X
2CT3016-X0340X
2CT3016-X0680X



② 2CT3016-X01H00



① 2CT3016-X034XX



② 2CT3016-X0480X

Accessories



2CT3000-X0000W 2CT3000-X0000D

Standard Size

Part No. : 2CT3040

Panel Mount Connector [Male Connector]

- Mating Style : Lock Type
- Current Rating : 5A
- Contact Gender : Female pin
- No. of Contacts : 6 pins

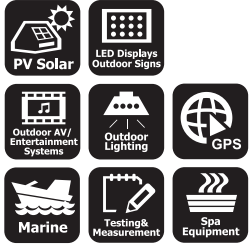

Physical Dimension

Panel Thickness : Max 2.0mm

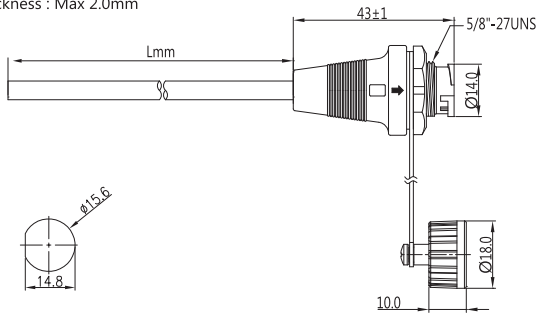

Standard Size

Part No. : 2CT3501

Shielded Panel Mount Solder Connector [Male Connector]

- Mating Style : Screw Type
- Current Rating : 5A
- Contact Gender : Male pin
- No. of Contacts : 8 pins

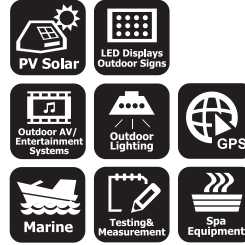

Physical Dimension

Panel Thickness : Max 4.4mm

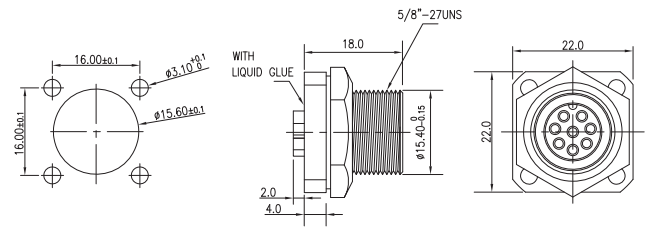

Pin Configurations and PCB Layouts



6 Pins

Pin Configurations and PCB Layouts



8 Pins

Mating Parts



2CT3016-X063XX

Mating Parts



2CT3505-XXX300



Standard Size

Part No. : 2CT3004/ 2CT3010

Molded with Cable [Female Connector]

- Mating Style : Lock Type
- Current Rating : 2A/ 5A/ 10A
- Contact Gender : Female pin
- No. of Contacts : 2-8/ 10/ 12 pins

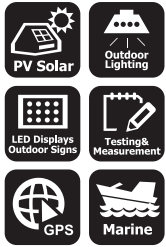

1 180° Lock
2CT3004-

2 90° Lock
2CT3010-

Pin Configurations and PCB Layouts

1 180° Lock Type	2 90° Lock Type	Rating	No. of Contacts
2CT3004-XXX200	2CT3010-XXX200	2A	10/12 pins
2CT3004-XXX300	2CT3010-XXX300	5A	4/5/6/7/8 pins
2CT3004-XXX400	2CT3010-XXX400	10A	2/3/4 pins

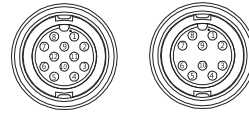

2A: 10 Pins

2A: 12 Pins



5A: 4 Pins

5A: 5 Pins

5A: 6 Pins

5A: 7 Pins

5A: 8 Pins

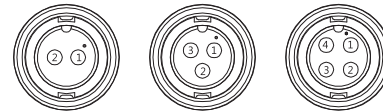

10A: 2 Pins

10A: 3 Pins

10A: 4 Pins

Physical Dimension

Cable OD : 1 Max Ø7.5mm
2 Max Ø6.5mm

Cable Length : Standard 1000mm (L: customized)

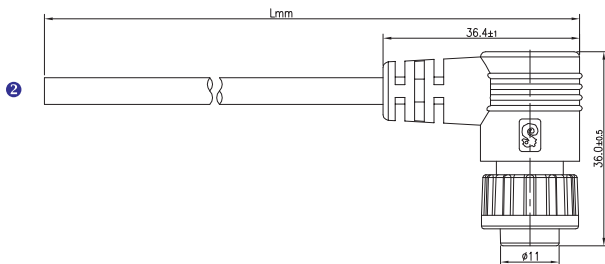
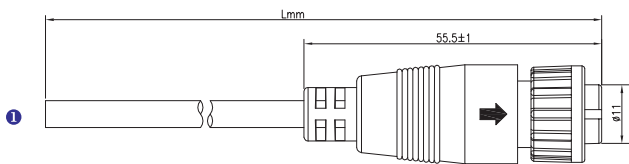

Mating Parts



2CT3024-XXX200
2CT3024-XXX300
2CT3024-XXX400

2CT3028-XXX200
2CT3028-XXX300
2CT3028-XXX400

2CT3000-XXX200
2CT3000-XXX300
2CT3000-XXX400

2CT3002-XXX200
2CT3002-XXX300
2CT3002-XXX400

Accessories



2CT3033-XXX200
2CT3033-XXX300
2CT3033-XXX400



2CT3024-X0000C

Standard Size

Part No. : 2CT3024/ 2CT3028

Molded with Cable [Male Connector]

- Mating Style : Lock Type
- Contact Gender : Male pin
- Current Rating : 2A/ 5A/ 10A
- No. of Contacts : 2-8/ 10/ 12 pins



1 180° Lock 2CT3024- 2 90° Lock 2CT3028-

Physical Dimension

Cable OD : 1 Max Ø7.5mm
2 Max Ø6.5mm

Cable Length : Standard 1000mm (L: customized)

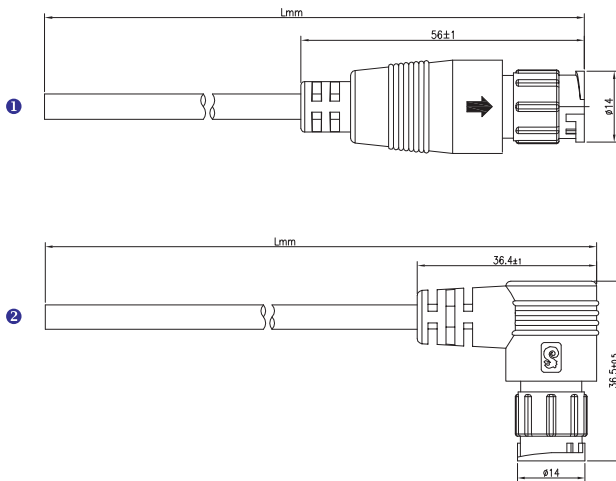

Pin Configurations and PCB Layouts

1 180° Lock Type	2 90° Lock Type	Rating	No. of Contacts
2CT3024-XXX200	2CT3028-XXX200	2A	10/12 pins
2CT3024-XXX300	2CT3028-XXX300	5A	4/5/6/7/8 pins
2CT3024-XXX400	2CT3028-XXX400	10A	2/3/4 pins

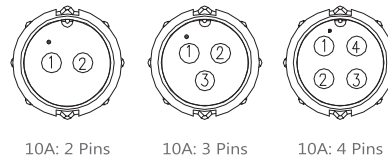
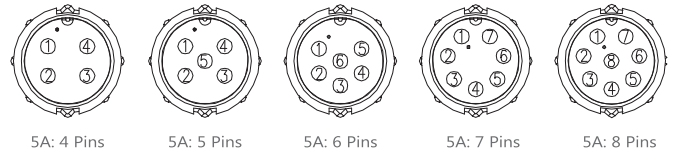
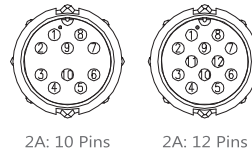

Mating Parts



- | | | |
|----------------|----------------|----------------|
| 2CT3004-XXX200 | 2CT3010-XXX200 | 2CT3032-XXX200 |
| 2CT3004-XXX300 | 2CT3010-XXX300 | 2CT3032-XXX300 |
| 2CT3004-XXX400 | 2CT3010-XXX400 | 2CT3032-XXX400 |

Accessories



2CT3004-X0000C

Standard Size

Part No.: 2CT3016

Molded with Cable [Female Connector]

- Mating Style : Lock Type
- Contact Gender : Male pin
- Current Rating : 5A/ 10A/ 5A+10A/ 50A
- No. of Contacts : 1/ 3/ 4/ 2+2/ 2+3/ 2+4 pins

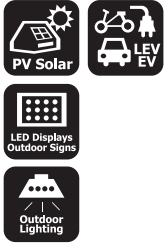

1
2CT3016-X0430X/ X03401
2CT3016-X0580X/ X0680X



2
2CT3016-X03402



3
2CT3016-X0480X



4
2CT3016-X01H00

Physical Dimension and Pin Configurations

Cable OD : Max Ø7.5mm 1 2 3
Max Ø9.0mm 4

Cable Length : Standard 1000mm (L: customized)

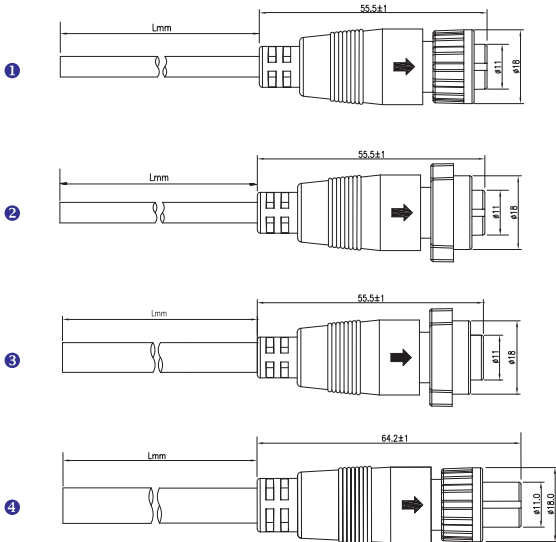

P/N	Rating	No. of Contacts
1 2CT3016-X0430X	5A	4 pins
1 2CT3016-X03401	10A	3 pins
1 2CT3016-X0580X	5A+10A	3+2 pins
1 2CT3016-X0680X	5A+10A	4+2 pins
2 2CT3016-X03402	10A	3 pins
3 2CT3016-X0480X	5A+10A	2+2 pins
4 2CT3016-X01H00	50A	1 pins

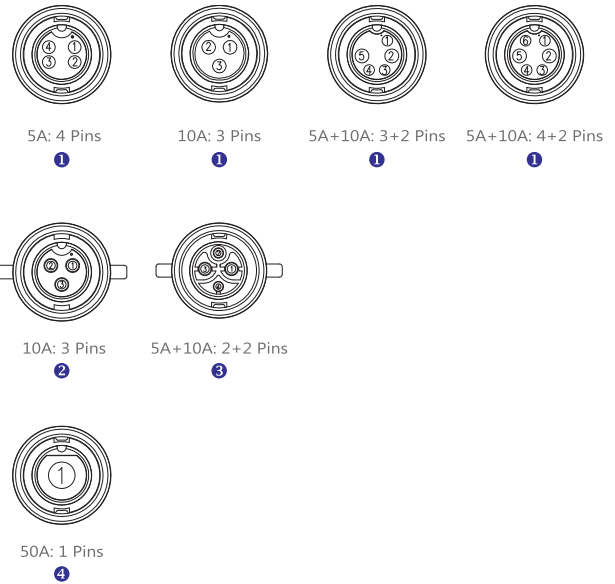

Mating Parts



1
2CT3014-X03400
2CT3014-X04300
2CT3014-X06800

2
2CT3020-X034AX

3
2CT3020-X048A0

1 2
2CT3030-X03402
2CT3030-X04806
2CT3030-X0580X
2CT3030-X0680X



4
2CT3014-X01H00

Standard Size

Part No. : 2CT3030

Molded with Cable [Male Connector]

- Mating Style : Lock Type
- Current Rating : 5A/10A/5A+10A
- Contact Gender : Female pin
- No. of Contacts : 3/4/2+2/2+3/2+4 pins

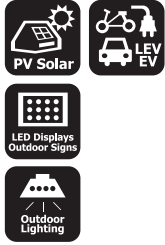

Physical Dimension

Cable OD : Max Ø7.0mm
Cable Length : Standard 1000mm (L: customized)

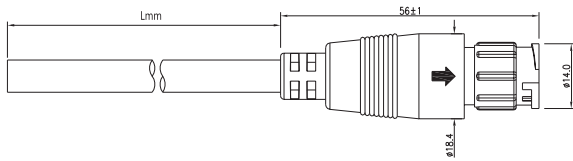

Pin Configurations and PCB Layouts

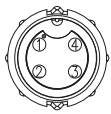

5A: 4 Pins

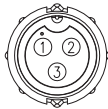

10A: 3 Pins



5A+10A: 2+2 Pins

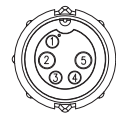

5A+10A: 3+2 Pins

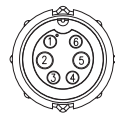

5A+10A: 4+2 Pins

Mating Parts



2CT3016-X0430X
2CT3016-X0580X
2CT3016-X0680X

2CT3016-X034XX

2CT3016-X0480X

Standard Size

Part No. : 2CT3505

Shielded Molded with Cable [Female Connector]

- Mating Style : 180° Screw Type
- Current Rating : 5A
- Contact Gender : Female pin
- No. of Contacts : 8 pins



Physical Dimension

Cable OD : Max Ø7.8mm
Cable Length : Standard 1000mm (L: customized)

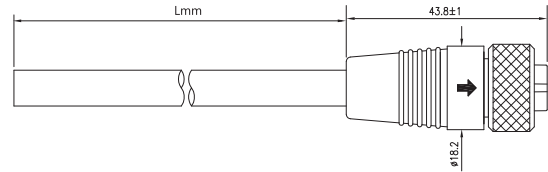

Pin Configurations and PCB Layouts

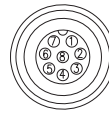

8 Pins

Mating Parts



2CT3501-XXX300



Standard Size

Part No. : 2CT3032

Field Installable (Solder) [Female Connector]

- Mating Style : Lock Type
- Current Rating : 2A/ 5A/ 10A
- Contact Gender : Female pin
- No. of Contacts : 2-8/ 10/ 12 pins

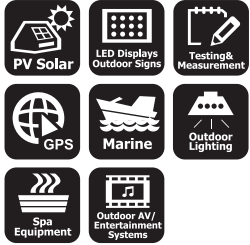

Pin Configurations and PCB Layouts

P/N	Rating	No. of Contacts
2CT3032-XXX200	2A	10/12 pins
① 2CT3032-XXX300	5A	2/3/4/5/6/7/8 pins
2CT3032-XXX400	10A	2/3/4 pins

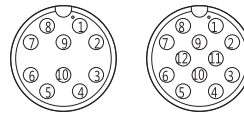

2A: 10 Pins 2A: 12 Pins



5A: 2 Pins 5A: 3 Pins 5A: 4 Pins 5A: 5 Pins 5A: 6 Pins

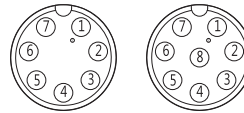

5A: 7 Pins 5A: 8 Pins

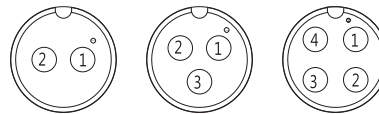

10A: 2 Pins 10A: 3 Pins 10A: 4 Pins

Physical Dimension

Cable OD : ① Ø4.0mm ~ Ø6.5mm
 ② Ø4.5mm ~ Ø7.0mm

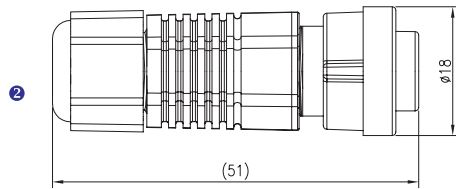
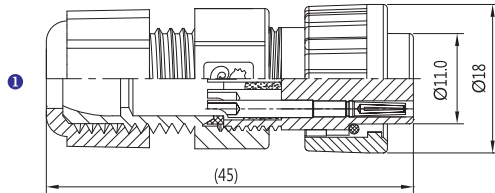

P/N	Rating	No. of Contacts
② 2CT3032-XXX4A0	10A	2/3/4 pins



10A: 2 Pins 10A: 3 Pins 10A: 4 Pins

Mating Parts



- | | | | |
|---|---|---|---|
| ①
2CT3000-XXX200
2CT3000-XXX300
2CT3000-XXX400 | ①
2CT3002-XXX200
2CT3002-XXX300
2CT3002-XXX400 | ①
2CT3024-XXX200
2CT3024-XXX300
2CT3024-XXX400 | ①
2CT3028-XXX200
2CT3028-XXX300
2CT3028-XXX400 |
|---|---|---|---|



- | | |
|---|---------------------|
| ①
2CT3033-XXX200
2CT3033-XXX300
2CT3033-XXX400 | ②
2CT3033-XXX4A0 |
|---|---------------------|

Accessories



2CT3024-X0000C

Standard Size

Part No. : 2CT3033

Field Installable (Solder) [Male Connector]

- Mating Style : Lock Type
- Contact Gender : Male pin
- Current Rating : 2A/ 5A/ 10A
- No. of Contacts : 2-8/ 10/ 12 pins

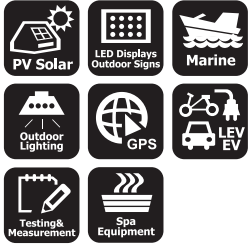

Physical Dimension

Cable OD : ① Ø4.0mm ~ Ø6.5mm; ② Ø4.5mm ~ Ø7.0mm

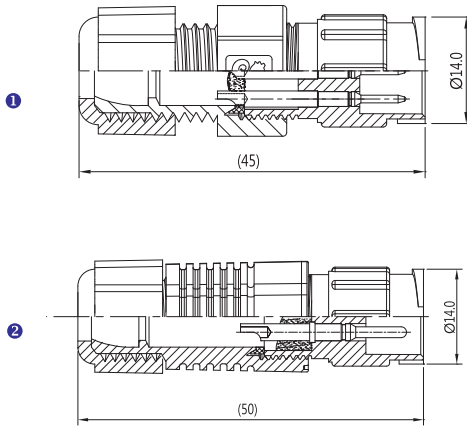

Pin Configurations and PCB Layouts

P/N	Rating	No. of Contacts
2CT3033-XXX200	2A	10/12 pins
① 2CT3033-XXX300	5A	2/3/4/5/6/7/8 pins
2CT3033-XXX400	10A	2/3/4 pins

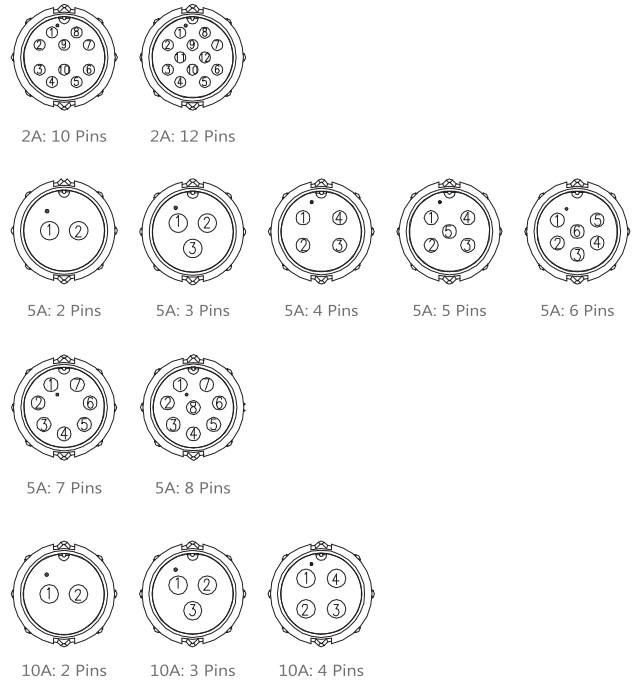

P/N	Rating	No. of Contacts
② 2CT3032-XXX4A0	10A	2/3/4 pins

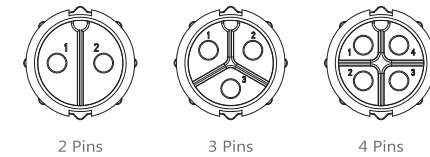

Mating Parts



- ① 2CT3004-XXX200
2CT3004-XXX300
2CT3004-XXX400
- ① 2CT3010-XXX200
2CT3010-XXX300
2CT3010-XXX400
- ① 2CT3032-XXX200
2CT3032-XXX300
2CT3032-XXX400



Accessories





Standard Size

Part No. : 2CT303Y-X04400

Y Adaptor, 10A

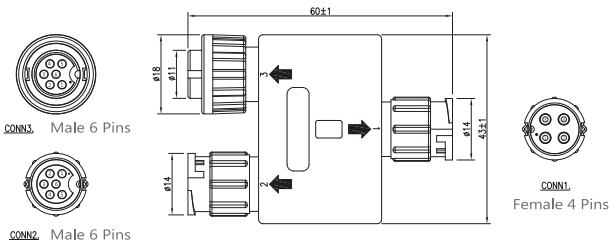

Standard Size

Part No. : 2CT3004-X0000C/ 2CT3024-X0000C

Waterproof Cap

2CT3024-X0000C

2CT3004-X0000C

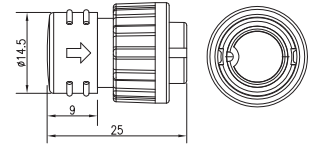
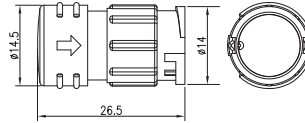

Standard Size

Part No. : 2CT303T-W02301

T Adaptor, 5A

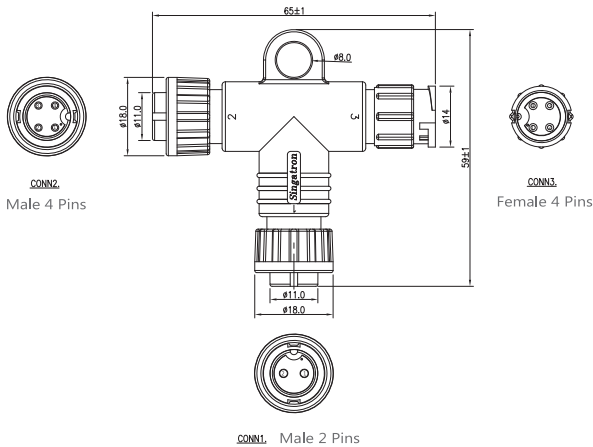

Standard Size

Part No. : 2CT3000-X0000D/
2CT3000-X0000W

Waterproof Cap

2CT3000-X0000W

2CT3000-X0000D

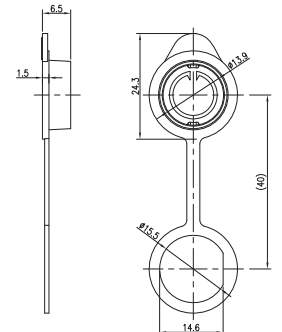
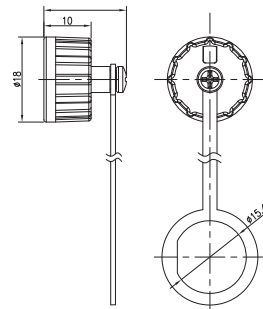

Middle Size

Part No. : 2CM3000/ 2CM3002

Panel Mount PCB/ Solder Connector [Male Connector]

- Mating Style : Lock Type
- Current Rating : 2A/ 5A/ 10A/ 16A/ 40A
- Contact Gender : Male pin
- No. of Contacts : 2-10/ 12/ 14-15/ 18 pins



1 PCB Pin
2CM3000-

2 Solder Pin
2CM3002-

Physical Dimension

Panel Thickness : Max 3.5 mm

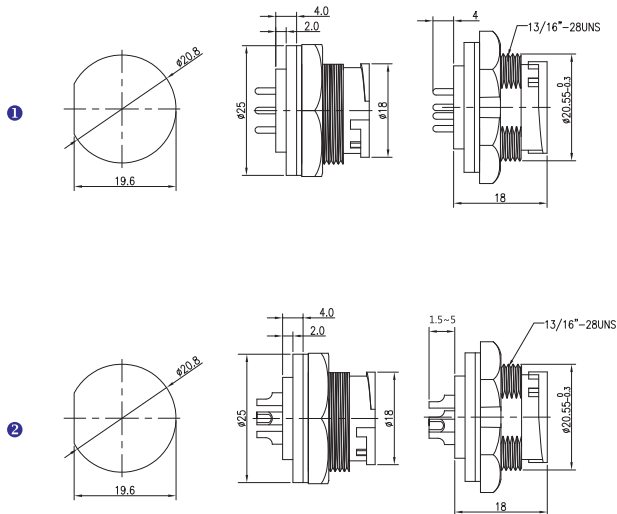

Pin Configurations and PCB Layouts

1 PCB Pin	Rating	No. of Contacts
2CM3000-XXX200	2A	18 pins
2CM3000-XXX300	5A	7/8/9 pins
2CM3000-XXX400	10A	4/5/6 pins
2CM3000-XXX600	16A	3 pins

2 Solder Pin	Rating	No. of Contacts
2CM3002-XXX200	2A	15/18 pins
2CM3002-XXX300	5A	7/8/9/10/12/14 pins
2CM3002-XXX400	10A	3/4/5/6 pins
2CM3002-XXX600	16A	3 pins
2CM3002-XXXH00	40A	2 pins

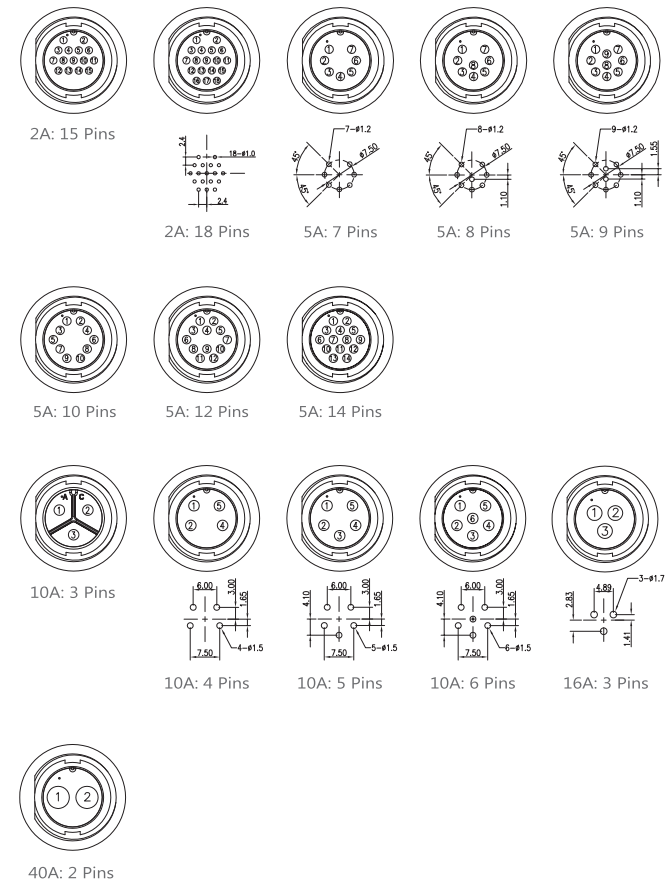

Mating Parts



Accessories



Middle Size

Part No. : 2CM3012/ 2CM3014

Panel Mount PCB/ Solder Connector [Male Connector]

- Mating Style : Lock Type
- Current Rating : 16A/ 2A+16A/ 2A+20A
- Contact Gender : Female pin
- No. of Contacts : 3/ 2+2/ 2+3/ 7+2 pins



1 PCB Pin
2CM3012-

2 Solder Pin
2CM3014-

Pin Configurations and PCB Layouts

1 PCB Pin	2 Solder Pin	Rating	No. of Contacts
-	2CM3014-X03600	16A	3 pins
-	2CM3014-XXXB00	2A+16A	2+2/ 3+2 pins
2CM3012-X09E00	2CM3014-X09E00	2A+20A	7+2 pins

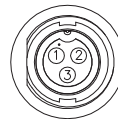

16A: 3 Pins

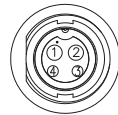

2A+16A: 2+2 Pins

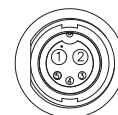

2A+16A: 3+2 Pins

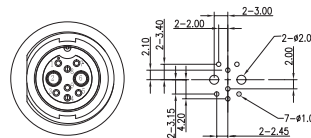

2A+20A: 7+2 Pins

Physical Dimension

Panel Thickness : Max 3.5 mm

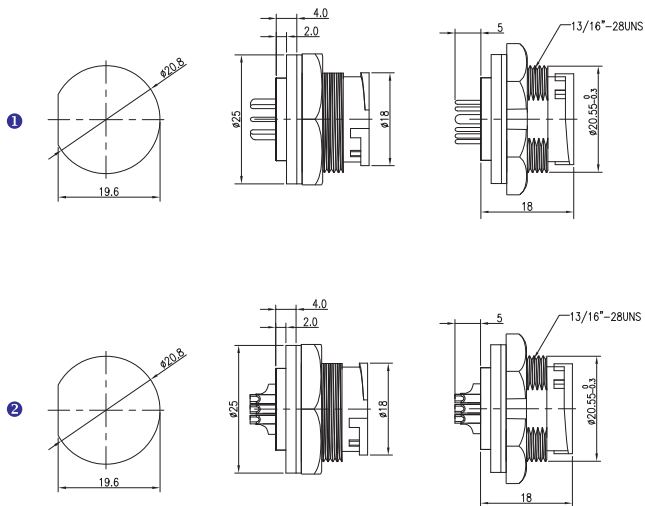

Mating Parts



2CM3016-X0360X
2CM3016-XXXB0X
2CM3016-X09E0X

Accessories



2CM3000-X0000W

2CM3000-X0000D

Middle Size

Part No. : 2CM3137-X03600H

Panel Mount Solder Connector [Male Connector]

- Mating Style : Lock Type
- Contact Gender : Female pin
- Current Rating : 20A
- No. of Contacts : 3 pins



Physical Dimension

Panel Thickness : Max 3.5mm

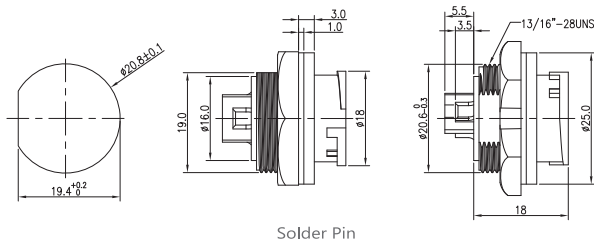

Solder Pin

Pin Configurations and PCB Layouts



3 Pins

Mating Parts



2CM3036-X03602

Accessories



2CM3000-X0000W

2CM3000-X0000D

Middle Size

Part No. : 2CM3040-X0930X

Panel Mount Connector [Male Connector]

- Mating Style : Lock Molded Type
- Contact Gender : Female pin
- Current Rating : 5A
- No. of Contacts : 9 pins



Physical Dimension

Cable OD : Max Ø10.0mm

Cable Length : Standard 1000mm (L: customized)

Panel Thickness : Max 2.0mm

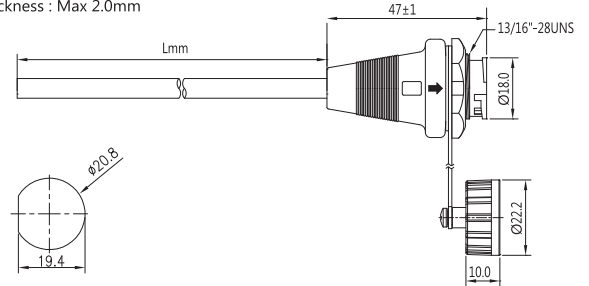

Pin Configurations and PCB Layouts

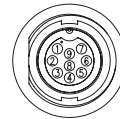

9 Pins

Mating Parts



2CM3016-X093XX

Middle Size

Part No. : 2CM3004/ 2CM3010

Molded with Cable [Female Connector]

- Mating Style : Lock Type
- Current Rating : 2A/ 5A/ 10A/ 16A/ 40A/ 5A+10A
- Contact Gender : Female pin
- No. of Contacts : 2-10/ 12/ 14/ 15/ 18/ 3+3 pins



Pin Configurations and PCB Layouts

180° Lock Type	90° Lock Type	Rating	No. of Contacts
① 2CM3004-XXX200	-	2A	15/18 pins
① 2CM3004-XXX300	③ 2CM3010-XXX300	5A	7/8/9/10/12/14 pins
② 2CM3004-X0340X	-	10A	3 pins
② 2CM3004-XXX400	③ 2CM3010-XXX400	10A	4/5/6 pins
① 2CM3004-XXX600	-	16A	3 pins
① 2CM3004-X0680X	-	5A+10A	3+3 pins
① 2CM3004-X02H00	-	40A	2 pins

Physical Dimension

Cable OD : Max Ø10.0mm
Cable Length : Standard 1000mm (L: customized)

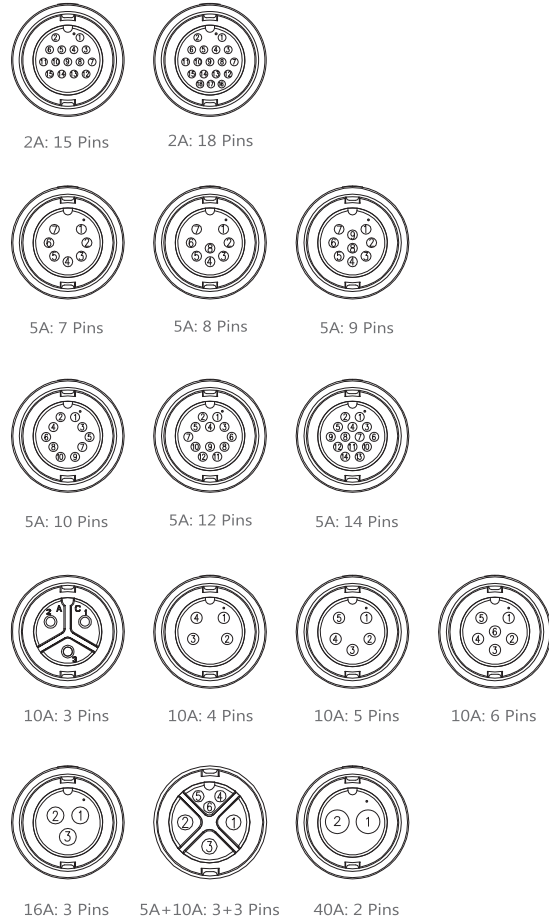
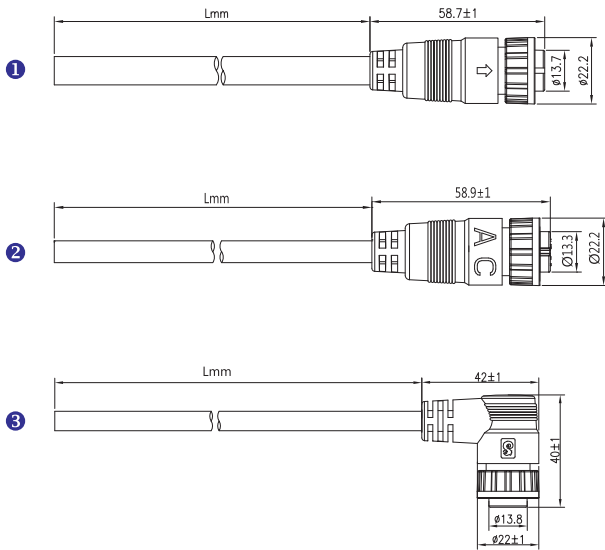

Mating Parts



- 2CM3000-XXX300
- 2CM3000-XXX400
- 2CM3000-XXX600
- 2CM3002-XXX200
- 2CM3002-XXX300
- 2CM3002-XXX400
- 2CM3002-XXX600
- 2CM3002-XXXH00
- 2CM3024-XXX300
- 2CM3024-XXX400
- 2CM3024-X0340X
- 2CM3024-XXX600
- 2CM3024-X0680X
- 2CM3033-XXX300
- 2CM3033-XXX400
- 2CM3033-X0340X
- 2CM3033-XXX600

Accessories



2CM3024-X0000C

Middle Size

Part No. : 2CM3024

Molded with Cable [Male Connector]

- Mating Style : Lock Type
- Current Rating : 5A/ 10A/ 16A/ 5A+10A
- Contact Gender : Male pin
- No. of Contacts : 3/ 7/ 8/ 9/ 3+3 pins



Physical Dimension

Cable OD : Max Ø10.0mm

Cable Length : Standard 1000mm (L: customized)

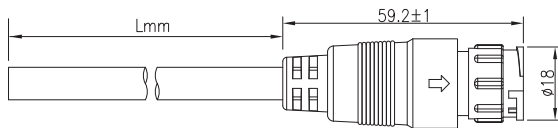

Pin Configurations and PCB Layouts

Type ①	Type ②	Rating	No. of Contacts
2CM3024-XXX300	-	5A	7/8/9 pins
2CM3024-X03420	2CM3024-X0340X	10A	3 pins
2CM3024-X03600	-	16A	3 pins
-	2CM3024-X0680X	5A+10A	3+3 pins

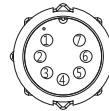

① 5A: 7 Pins

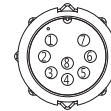

① 5A: 8 Pins

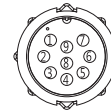

① 5A: 9 Pins

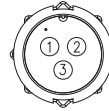

① 10A: 3 Pins

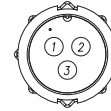

① 16A: 3 Pins

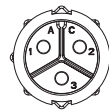

2CM3024-X03402
② 10A: 3 Pins

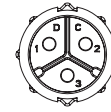

2CM3024-X03403
② 10A: 3 Pins



2CM3024-X0680X
② 5A+10A: 3+3 Pins

Mating Parts



①
2CM3004-XXX300
2CM3004-X0340X
2CM3004-X0360X

①
2CM3032-XXX300
2CM3032-X0340X
2CM3032-X0360X

②
2CM3004-X0340X
2CM3004-X0680X

②
2CM3032-X0340X

Accessories



2CM3004-X0000C

Middle Size

Part No. : 2CM3016

Molded with Cable [Female Connector]

- Mating Style : Lock Type
- Contact Gender : Male pin
- Current Rating : 16A/2A+16A/2A+20A
- No. of Contacts : 3/2+2/3+2/7+2 pins



Physical Dimension

Cable OD : Max \varnothing 10.0mm
Cable Length : Standard 1000mm (L: customized)

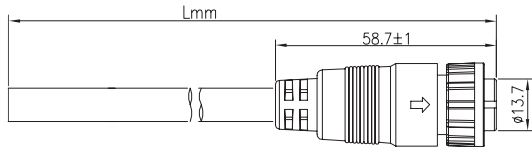

Pin Configurations and PCB Layouts



16A: 3 Pins



2A+16A: 2+2 Pins



2A+16A: 3+2 Pins



2A+20A: 7+2 Pins

Middle Size

Part No. : 2CM3030

Molded with Cable [Male Connector]

- Mating Style : Lock Type
- Contact Gender : Female pin
- Current Rating : 16A/ 2A+20A
- No. of Contacts : 3/ 7+2 pins



Physical Dimension

Cable OD : Max \varnothing 10.0mm
Cable Length : Standard 1000mm (L: customized)

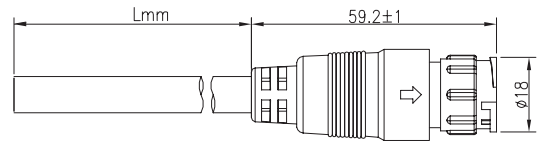

Pin Configurations and PCB Layouts

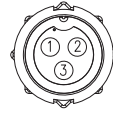

16A: 3 Pins

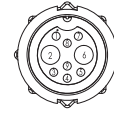

2A+20A: 7+2 Pins

Mating Parts



2CM3014-X09E00
2CM3014-X03600
2CM3014-XXXB00



2CM3012-X09E0X



2CM3030-X09E0X
2CM3030-X0360X

Accessories



2CM3024-X0000C

Mating Parts



2CM3016-X0360X
2CM3016-X09E0X

Middle Size

Part No. : 2CM3032

Field Installable (Solder) [Female Connector]

- Mating Style : Lock Type
- Contact Gender : Female pin
- Current Rating : 5A/ 10A/ 16A/ 20A
- No. of Contacts : 3-9 pins



Physical Dimension

Cable OD : Ø3.0mm ~ Ø6.0mm; Ø6.0mm ~ Ø9.0mm

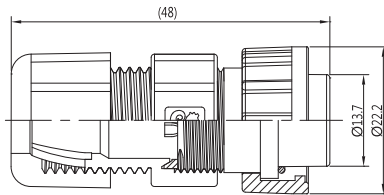

Pin Configurations and PCB Layouts

Type ①	Type ②	Rating	No. of Contacts
2CM3032-XXX300	-	5A	7/8/9 pins
-	2CM3032-X0340X	10A	3 pins
2CM3032-XXX400	-	10A	4/5/6 pins
2CM3032-X03600	-	16A	3 pins
-	2CM3032-X03604	20A	3 pins

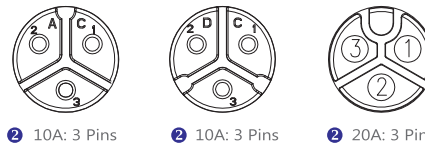
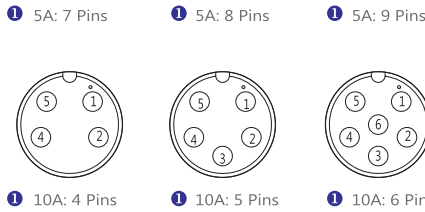
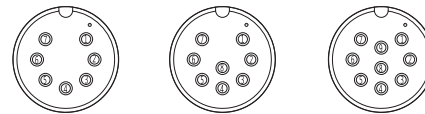

Mating Parts



- ① 2CM3000-XXX300
2CM3000-XXX400
2CM3000-X03600
- ① 2CM3002-XXX300
2CM3002-XXX400
2CM3002-X03600
- ① ② 2CM3033-XXX300
2CM3033-X0340X
2CM3033-XXX400
2CM3033-X0360X
- ① ② 2CM3024-XXX300
2CM3024-X0340X
2CM3024-XXX400
2CM3024-X0360X



Accessories



Middle Size

Part No. : 2CM3033

Field Installable (Solder) [Male Connector]

- Mating Style : Lock Type
- Current Rating : 5A/ 10A/ 16A/ 20A
- Contact Gender : Male pin
- No. of Contacts : 3-9 pins



Pin Configurations and PCB Layouts

P/N	Rating	No. of Contacts
1 2CM3033-XXX300	5A	7/8/9 pins
1 2CM3033-XXX400	10A	4/5/6 pins
1 2CM3033-XXX600	16A	3 pins
2 2CM3033-X0340X	10A	3 pins
2 2CM3033-X03601	20A	3 pins

Physical Dimension

Cable OD : Ø3.0mm ~ Ø6.0mm; Ø6.0mm ~ Ø9.0mm

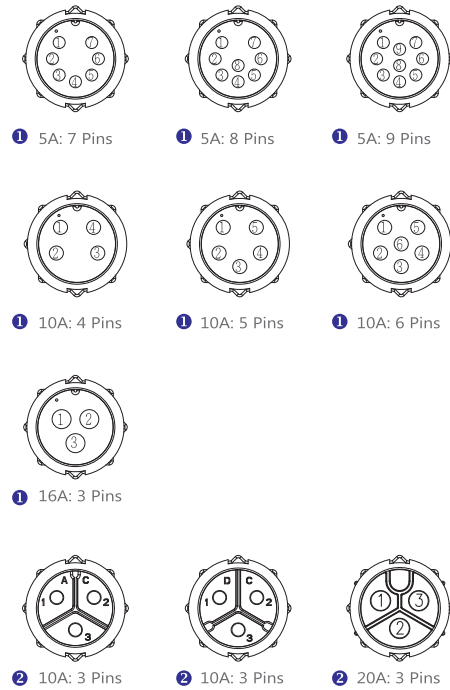
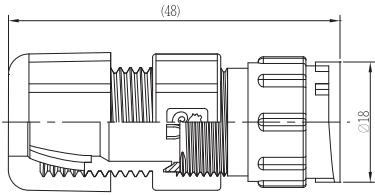

Mating Parts



Accessories



Middle Size

Part No. : 2CM3036

Field Installable (Solder) [Female Connector]

- Mating Style : Lock Type
- Contact Gender : Male pin
- Current Rating : 20A/ 2A+20A
- No. of Contacts : 3/ 7+2 pins



Physical Dimension

Cable OD : Ø6.0mm ~ Ø9.0mm

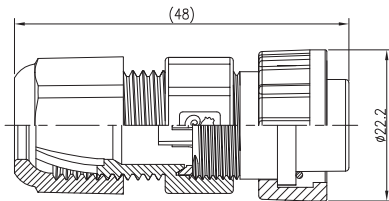

Pin Configurations and PCB Layouts



2CM3036-X03602
20A: 3 Pins



2CM3036-X09E00
2A+20A: 7+2 Pins

Middle Size

Part No. : 2CM3037

Field Installable (Solder) [Male Connector]

- Mating Style : Lock Type
- Contact Gender : Female pin
- Current Rating : 20A/ 2A+20A
- No. of Contacts : 3/ 7+2 pins



Physical Dimension

Cable OD : Ø6.0mm ~ Ø9.0mm

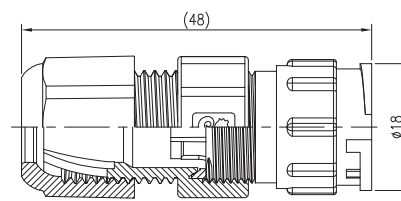

Pin Configurations and PCB Layouts



2CM3037-X03601
20A: 3 Pins

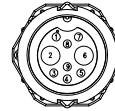

2CM3037-X09E00
2A+20A: 7+2 Pins

Mating Parts



2CM3037-X03601
2CM3037-X09E00

2CM3137-X03600

Accessories



2CM3024-X0000C

Mating Parts



2CM3036-X03602
2CM3036-X09E00

Accessories



2CM3004-X0000C



Circular

IP66 • IP67 • IP68

Mini Size • Standard Size • Middle Size • Large Size • Macro Size

Middle Size

Part No. : 2CM3024-X0000C

Waterproof Cover

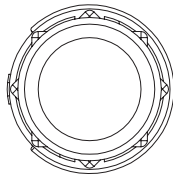
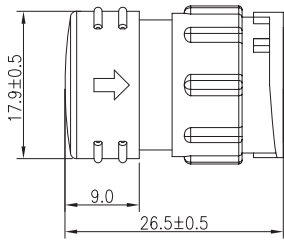

Middle Size

Part No. : 2CM3000-X0000W

Waterproof Cap

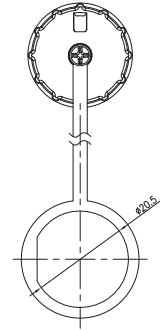
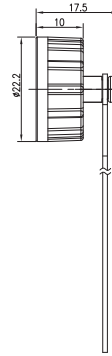

Middle Size

Part No. : 2CM3004-X0000C

Waterproof Cover

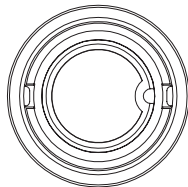
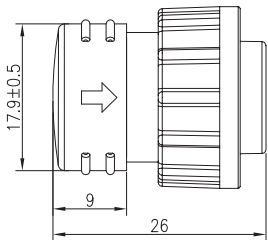

Middle Size

Part No. : 2CM30000-X0000D

Waterproof Cap

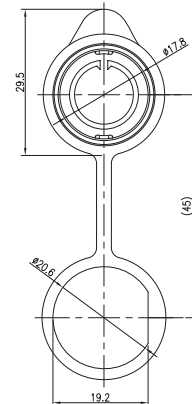
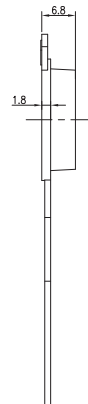

Large Size

Part No. : 2CG3000/ 2CG3002

Panel Mount PCB/Solder Connector [Male Connector]

- Mating Style : Lock Type ■ Current Rating : 5A/ 20A/ 40A/ 5A+20A
- Contact Gender : Male pin ■ No. of Contacts : 2/ 3/ 12/ 18/ 9+3 pins



1 PCB Male Pins



2 Solder Male Pins



3 Solder Male&Female Pins

Physical Dimension and Pin Configurations

Panel Thickness : Max 3.5mm

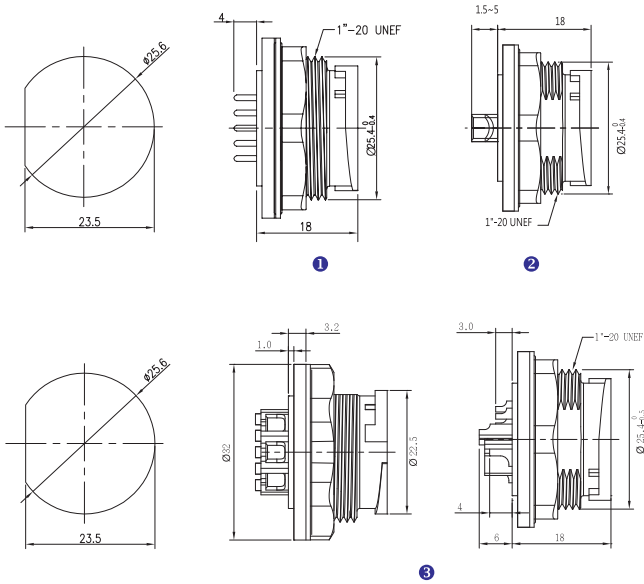

PCB Pin	Solder Pin	Rating	No. of Contacts
-	2 2CG3002-X12300	5A	12 pins
1 2CG3000-X18300	2 2CG3002-X18300	5A	18 pins
-	2 2CG3002-X03600	20A	3 pins
-	2 2CG3002-X02G00	40A	2 pins
-	3 2CG3002-X12F00	5A+20A	9+3 pins

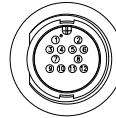

5A: 12 Pins

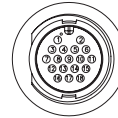

5A: 18 Pins

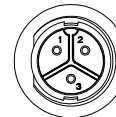

20A: 3 Pins

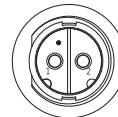

40A: 2 Pins



5A+20A: 9+3 Pins

Mating Parts



2CG3004-X1230X
2CG3004-X1830X
2CG3004-X0360X

2CG3004-X02G00

2CG3010-X02G00
2CG3010-X1230X

2CG3004-X12F0X

Accessories



2CG3000-X0000W

Large Size

Part No. : 2CG3012/ 2CG3014

Panel Mount PCB/ Solder Connector [Male Connector]

- Mating Style : Lock Type
- Contact Gender : Female pin
- Current Rating : 5A
- No. of Contacts : 12/ 16/ 18 pins



Physical Dimension

Panel Thickness : Max 3.5mm

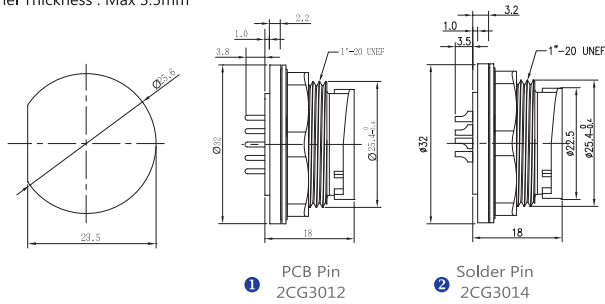

Pin Configurations and PCB Layouts

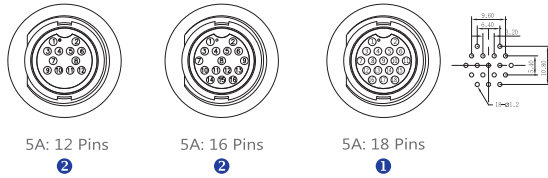

Mating Parts



2CG3016-XXX30X

Accessories



2CG3000-X0000W

Large Size

Part No. : 2CG3015

Panel Mount Solder Connector [Male Connector]

- Mating Style : Screw Type
- Contact Gender : Female pin
- Current Rating : 5A+20A
- No. of Contacts : 4+2 pins



Physical Dimension

Panel Thickness : Max 3.5mm

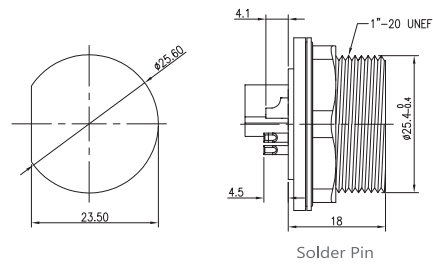

Pin Configurations and PCB Layouts



Mating Parts



2CG3017-X06F0X

Large Size

Part No. : 2CG3037

Panel Mount Solder Connector [Female Connector]

- Mating Style : Lock Type
- Current Rating : 5A+20A
- Contact Gender : Male&Female pin
- No. of Contacts : 9+3 pins



Physical Dimension

Panel Thickness : Max 3.5mm

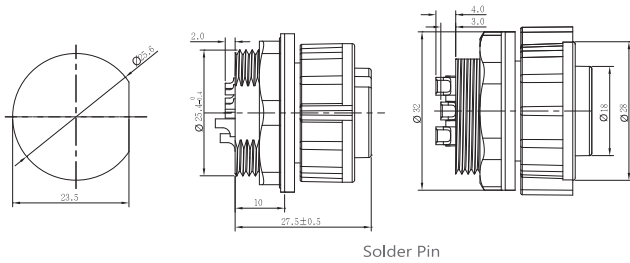

Pin Configurations and PCB Layouts

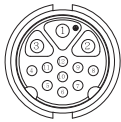

9+3 Pins

Mating Parts



2CG3024-X12F0X

Large Size

Part No. : 2CG3004/ 2CG3010

Molded with Cable [Female Connector]

- Mating Style : Lock Type
- Contact Gender : ① ② Female pin; ③ Male&Female pin
- Current Rating : 5A/ 20A/ 40A/ 5A+20A
- No. of Contacts : 2/ 3/ 12/ 18/ 9+3 pins



① 180° Lock 2CG3004- ② 90° Lock 2CG3010- ③ Jumper Cable (Male to Female) 2CG3004-X12F0X

Physical Dimension and Pin Configurations
 Cable OD : Max Ø13.5mm
 Cable Length : Standard 1000mm (L: customized)

180° Lock		90° Lock		Rating	No. of Contacts
①	2CG3004-X1230X	②	2CG3010-X1230X	5A	12 pins
①	2CG3004-X183XX	-	-	5A	18 pins
①	2CG3004-X0360X	-	-	20A	3 pins
①	2CG3004-X02G00	②	2CG3010-X02G00	40A	2 pins
③	2CG3004-X12F0X	-	-	5A+20A	9+3 pins

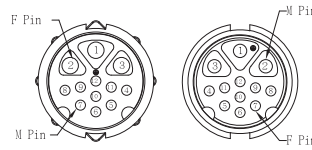
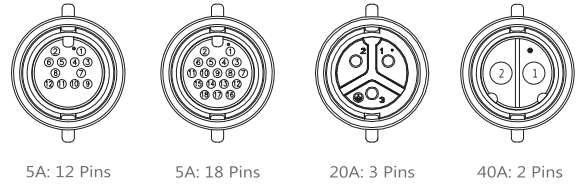
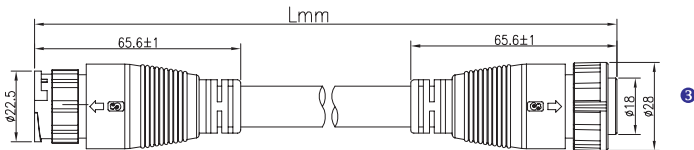
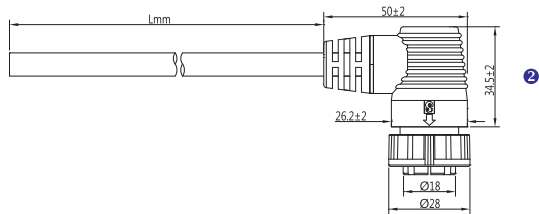
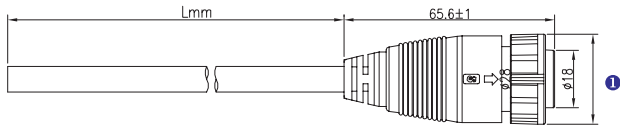

Mating Parts



Large Size

Part No. : 2CG3016

Molded with Cable [Female Connector]

- Mating Style : Lock Type
- Contact Gender : Male pin
- Current Rating : 5A
- No. of Contacts : 12/16/18 pins



Physical Dimension

Cable OD : Max Ø9.0mm
Cable Length : Standard 1000mm (L: customized)

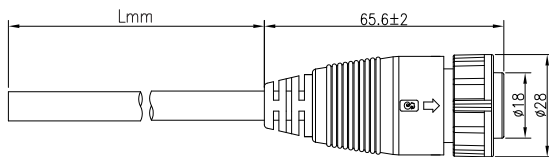

Pin Configurations and PCB Layouts

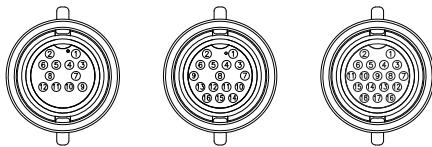

5A: 12 Pins

5A: 16 Pins

5A: 18 Pins

Mating Parts



2CG3014-XXX300

Large Size

Part No. : 2CG3017

Molded with Cable [Female Connector]

- Mating Style : Screw Type
- Contact Gender : Male pin
- Current Rating : 5A+20A
- No. of Contacts : 4+2 pins



Physical Dimension

Cable OD : Max Ø13.5mm
Cable Length : Standard 1000mm (L: customized)

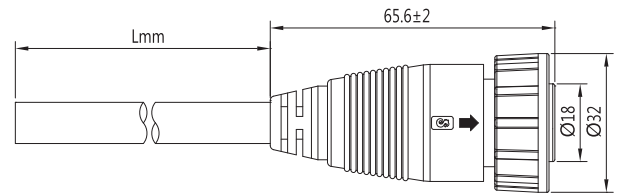

Pin Configurations and PCB Layouts

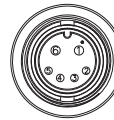

4+2 Pins

Mating Parts



2CG3015-X06F00

Large Size

Part No. : 2CG3024

Molded with Cable [Male Connector]

- Mating Style : Lock Type
- Contact Gender : Male pin
- Current Rating : 5A/ 5A+20A
- No. of Contacts : 18/ 9+3 pins



① 2CG3024-X1830X
Male Pin

② 2CG3024-X12FOX
Male&Female Pin

Physical Dimension

Cable OD : Max Ø13.5mm

Cable Length : Standard 1000mm (L: customized)

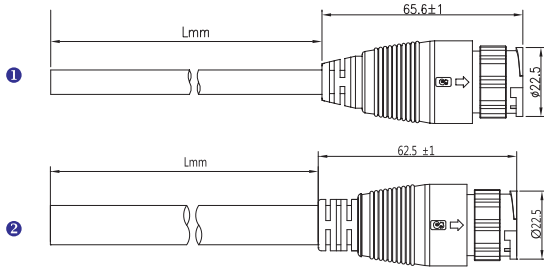

Pin Configurations and PCB Layouts



① 5A: 18 Pins

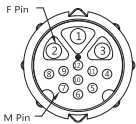

② 5A+20A: 9+3 Pins

Mating Parts



① 2CG3004-X1830X

② 2CG3037-X12F00

② 2CG3004-X12FOX

Large Size

Part No. : 2CG3000-X0000W

Waterproof Cap

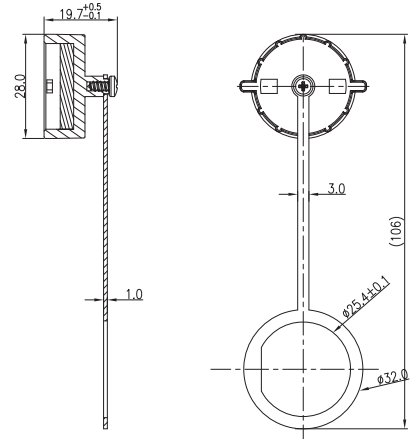



Since 1976
SINGATRON GROUP
Specialized Connector Manufacturer



✉ sales@singatron.com.tw
www.singatron.com.tw
www.singatron.com.cn

● **Taiwan Headquarters**

Singatron Enterprise Co., Ltd.

No.209, Sec. 2, Zhongzheng Road, Hukou Township
Hsinchu County 30343, Taiwan
Tel +886-3-599 2862 Fax +886-3-599 5601

● **Suzhou, China Plant**

Singatron Electronic (China) Co., Ltd.

Suzhou Singatron Auto Co., Ltd.

No.509, Xinfeng Road, Xujiang Industrial Park, Xukou Town
Suzhou City, Jiangsu Province 215164, China
Tel +86-512-6687 7188 Fax +86-512-6687 7288

● **Zhongshan, China Plant**

Singatron Electronic (Zhongshan) Co., Ltd.

Building A1& A3, No.17, Fuze Road, Gaoping Industrial Area, Sanjiao Town
Zhongshan City, Guangdong Province 528445, China
Tel +86-760-8540 3451 Fax +86-760-8540 3452

● **Yancheng, China Plant**

Suzhou Singatron Connector Co., Ltd., Yancheng Branch

No.8, Qianjin North Road, Bufeng Town Industrial Park, Economic Development Zone
Yancheng City, Jiangsu Province 224045, China
Tel +86-515-8882 7860 Fax +86-515-8882 7860-224

SGconn[®]
Waterproof Connectors

Singatron reserves the right to make any changes and updates for design and specification at any time without notice. More information please visit www.singatron.com.tw or contact us.